

Perfecting the Air

SkyAir

AIR CONDITIONING SYSTEM
COOLING ONLY [50Hz]

INVERTER

WORLD'S FIRST
R32
REFRIGERANT



Very Good

5 stars

\$536 1986kWh

Split type (Inverter) Air conditioner
Cooling Capacity: 3.08 kW

RZF50CV1G
RZF60CV1G

Good

4 stars

\$434 1606kWh

Split type (Inverter) Air conditioner
Cooling Capacity: 3.28 kW

RZFC35EV1G
RZF71CV1G
RZF100CV1G

Fair

3 stars

\$1356 5022kWh

Split type (Inverter) Air conditioner
Cooling Capacity: 8.18 kW

RZFC50DV1G
RZFC60DV1G • RZFC71DV1G
RZFC100DV1G • RZF125CV1G
RZFC125DV1G • RZFC140DV1G

R-32

Daikin Environment Vision 2050

Air conditioners have become an important key infrastructure for supporting the global community with greater emphasis on indoor air quality (IAQ). Demand for air conditioning is expected to triple by 2050 from current demand with the economic development in emerging countries, as well as other factors.

Under Daikin Environmental Vision 2050 established in fiscal 2018, we are tackling challenges associated with the reduction of greenhouse gas emissions to net-zero. Through embarking on digitalization and the development of greener products and services that contribute to energy conservation, we are confident of contributing positively to mitigating global warming.





SUSTAINABILITY

Embarking on green initiatives

Refer to page 10 & 11



DIGITALIZATION

Improve control of SkyAir units with Daikin Smart Solutions

Refer to page 65 & 66



INDOOR AIR QUALITY (IAQ)

Ensure the air in your premises is clean and disinfect with Daikin IAQ Solutions (Options)

Refer to page 67



Designed for use in shops, restaurants and small offices, Daikin SkyAir split systems provides a comfortable environment for building occupants all year round and offers building owners substantial operating efficiencies to help minimise operating costs.



Ceiling Mounted Cassette Type

<Round Flow>

Building on Daikin's signature Round Flow design to deliver greater comfort and energy efficiency.



Compact Multi Flow Ceiling Mounted Cassette Type

The fully flat cassette is a remarkable blend of iconic design and engineering excellence.



Duct Connection Middle Static Pressure Type

Compact form factor with powerful features for ultimate design flexibility.



Ceiling Suspended Type

Ceiling suspended indoor units cool the largest spaces without compromising wall space.



Wall Mounted Type

Sophisticated design delivers wide angle airflow and long throws for greater comfort.

Designed for use in
**CAFE AND RESTAURANTS,
RETAIL SHOPS AND SMALL OFFICES.**





DAIKIN'S SKYAIR SERIES delivers superior comfort and energy performance for both occupants and building owners.



CONTENTS

R-32 REFRIGERATION	P.10-11
LINEUP	P.12-13
DAIKIN SKYAIR SERIES	P.14-20
Energy Saving	P.14
Quick Cooling	P.15
Smart Airflow Control	P.16
Durability	P.17
Convenient Functions	P.18
Design Flexibility	P.19
Reuse of Existing Piping	P.20
INDOOR UNIT	P.22-41
Ceiling Mounted Cassette type <Round Flow>	P.22-33
Compact Multi Flow Ceiling Mounted Cassette Type	P.34-35
Duct Connection Middle Static Pressure Type	P.36-37
Ceiling Suspended Type	P.38-39
Wall Mounted Type	P.40-41
OUTDOOR UNIT	P.42-43
REMOTE CONTROLLER	P.44-49
FUNCTIONS	P.50-55
SPECIFICATIONS	P.56-60
OPTIONS	P.60-64
SMART CONTROL	P.65
WIFI CONNECTION ADAPTOR	P.66
INDOOR AIR QUALITY (IAQ)	P.67

Next-Generation R-32 Refrigerant

Daikin is the sole worldwide manufacturer of both air conditioning equipment and refrigerants. We are continuously researching refrigerants as well as new technologies which can reduce energy consumption.

With climate change now a critical issue, low impact refrigerants are urgently required. We have adopted R-32, a next-generation refrigerant which does not deplete the ozone layer and has minimal effect on global warming

R-32

From R-410A to R-32, Another step towards lower global warming potential.

If you want a new HFC refrigerant with zero ozone depletion potential, which also has a lower global warming potential than R-410A, use **R-32**.

Achieving new levels of energy efficiency while responding to environmental needs, Daikin has redesigned the SkyAir series from the ground up using R-32.

*1. Source: Values for 100-year global warming potential (GWP) from IPCC Fourth Assessment Report. Comparative 100-year GWP: HFC410A, 2,090; HFC32, 675.

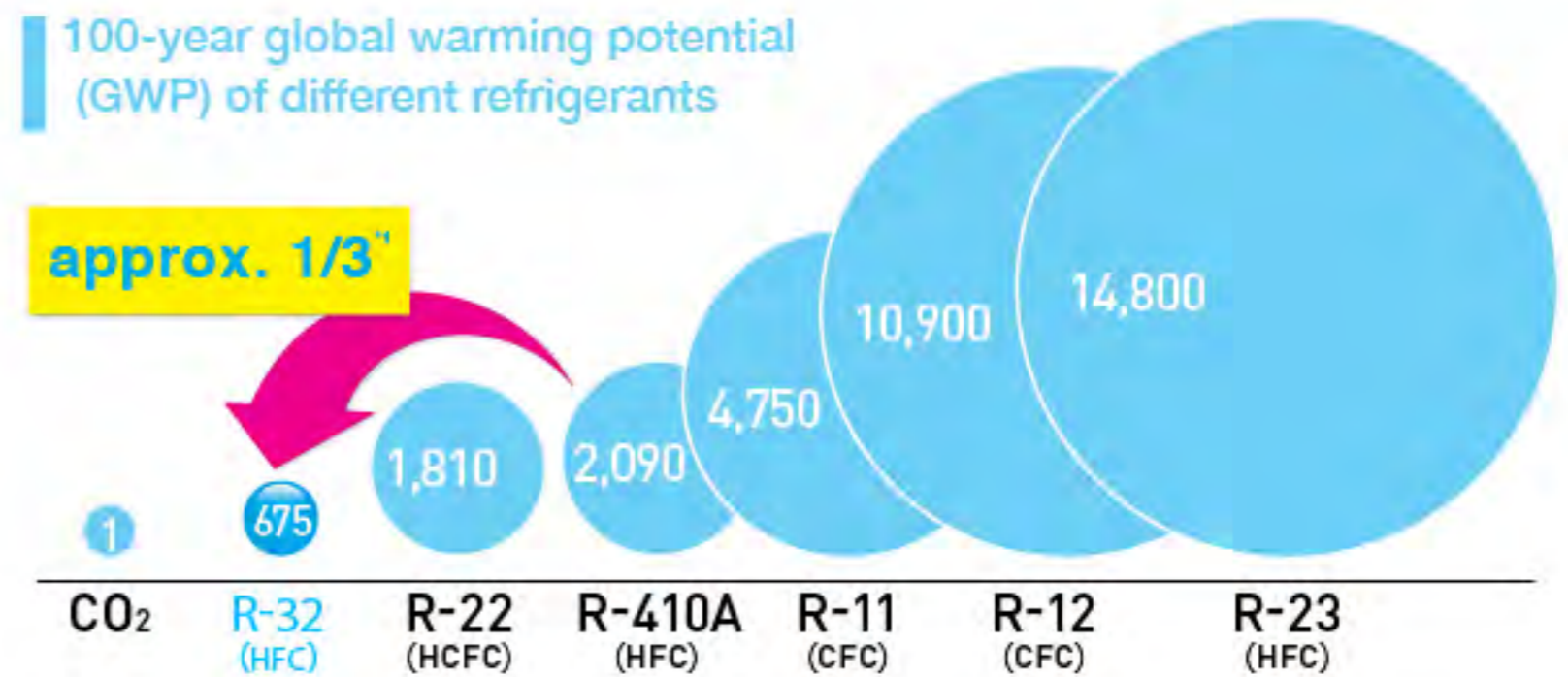

Environmental Impact of Air Conditioner Refrigerants Trends.

	Ozone depletion potential (ODP)	100 year global warming potential of different refrigerants ²
R-12 (CFC)	1.0	10,900
R-22 (HCFC)	0.055	1,810
R-410A (HFC)	0	2,090
R-32 (HFC)	0	675

*2. Values for 100 year global warming potential (GWP) from IPCC fourth assessment report comparative 100 year GWP: HFC410A, 2,090; HFC32, 675.

Smaller Impact on Environment

R-32 has zero ODP (Ozone Depletion Potential) and its GWP (Global Warming Potential) is 675, which is lower than the GWP of R-410A or R-22.

It could reduce the charging volume by 30% compared to R-410A.

Thus, these factors mean R-32 has just 23% of the theoretical impact on global warming of R-410A.

Theoretical Modified GWP

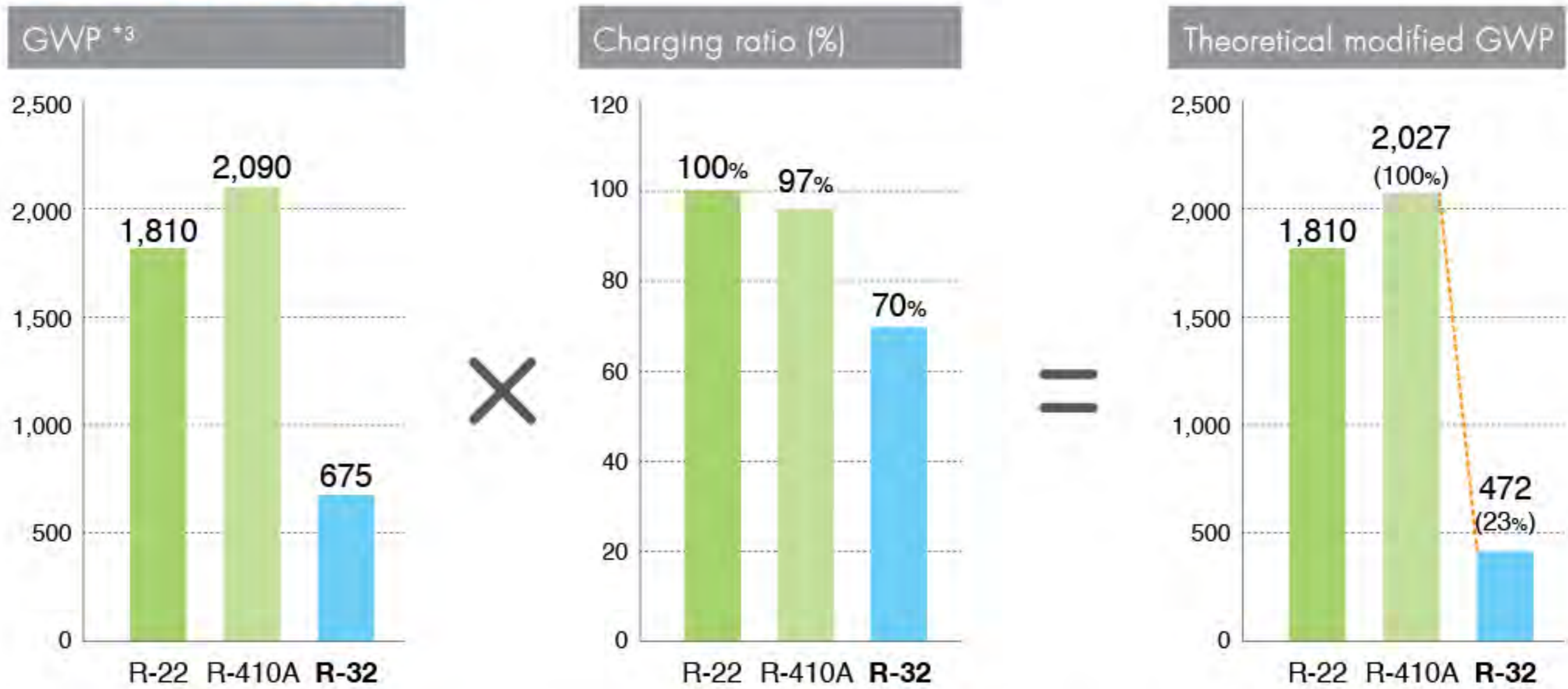

*3. GWP values are based on the Fourth Assessment Report from the Intergovernmental Panel on Climate Change (IPCC 4th AR).

High Energy Efficiency

The peak power consumption of R-32 is lower than conventional refrigerants, helping to alleviate power shortages in large cities during periods of high demand.

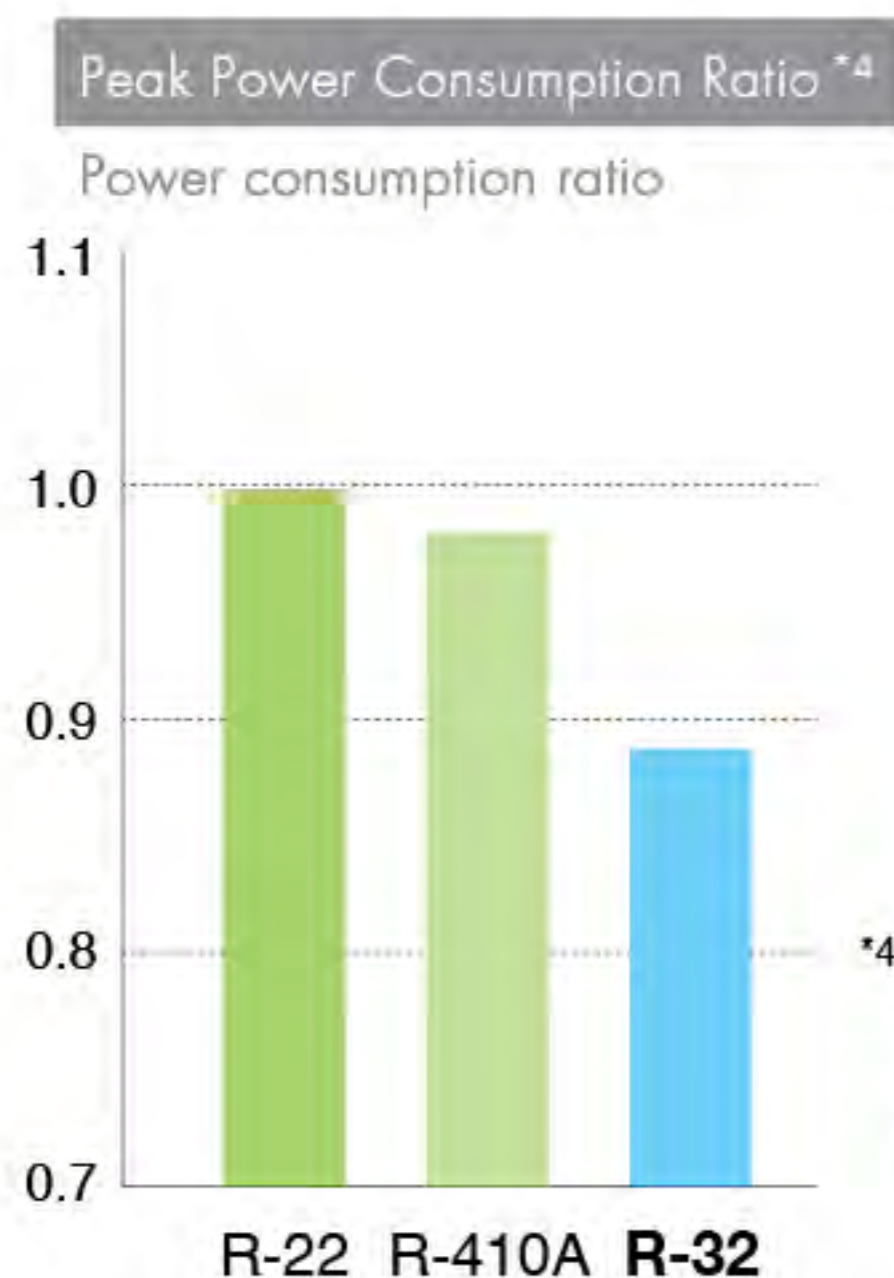

*4. Preconditions for calculations

- 3.5 kW split-type cooling only model
- Peak power consumptions are based on indoor/outdoor temperatures of 27/35°CDB.
- Values show test results in Asia, which includes India, Indonesia and Malaysia, but not China.



Cooling only

		35	50	60
CEILING MOUNTED CASSETTE TYPE <i>ROUND FLOW</i> <Round Flow>	Indoor unit			
	Outdoor unit		RZF50CV1G	RZF60CV1G
COMPACT MULTI FLOW CEILING MOUNTED CASSETTE TYPE	Indoor unit			
	Outdoor unit	RZFC35EV1G	RZFC50DV1G	
DUCT CONNECTION MIDDLE STATIC PRESSURE TYPE	Indoor unit			
	Outdoor unit		RZFC50DV1G	RZFC60DV1G
*NEA Energy Label is not required.				
CEILING SUSPENDED TYPE	Indoor unit			
	Outdoor unit		RZFC50DV1G	RZFC60DV1G
WALL MOUNTED TYPE	Indoor unit			
	Outdoor unit			
OUTDOOR UNIT	Outdoor unit	  RZFC35EV1G	  RZF50CV1G  RZFC50DV1G	  RZF60CV1G  RZFC60DV1G
	Power supply	1 phase, 220-240V, 50Hz	1 phase, 220-240V, 50Hz	1 phase, 220-240V, 50Hz

71		100		125		140		
								Page 22
FCF71CVMG		FCF100CVMG FCFC100DVMG		FCF125CVMG FCFC125DVMG		FCFC140DVMG		
RZF71CV1G		RZF100CV1G RZFC100DY1G		RZF125CV1G RZFC125DY1G		RZFC140DY1G		Page 34
								Page 36
FBFC71DVMG		FBFC100DVMG		FBFC125DVMG		FBFC140DVMG		
RZFC71DV1G		RZFC100DV1G RZFC100DY1G		RZFC125DV1G RZFC125DY1G		RZFC140DV1G RZFC140DY1G		Page 38
								Page 40
FHFC71DV1G		FHFC100DV1G		FHFC125DV1G		FHFC140DV1G		
RZFC71DV1G		RZFC100DV1G RZFC100DY1G		RZFC125DV1G RZFC125DY1G		RZFC140DV1G RZFC140DY1G		Page 42
		FAFC100AV1G						Page 42
		RZFC100DV1G						
								Page 42
RZF71CV1G		RZF100CV1G		RZF125CV1G		RZFC140DV1G		
								Page 42
RZFC71DV1G		RZFC100DV1G RZFC100DY1G		RZFC125DV1G RZFC125DY1G		RZFC140DY1G		
1 phase, 220-240V, 50Hz		1 phase, 220-240V, 50Hz		3 phase, 380-415V, 50Hz		1 phase, 220-240V, 50Hz		Page 42

FEATURES & FUNCTIONS

Cooling only

R-32

Energy Saving

- ◆ Throughout the cooling season, Daikin's new inverter models reduce energy consumption



● Weighted COP value by capacity for cassette models



Quick Cooling

◆ Faster cooling and dehumidification

RZF series

New inverter control technology brings quick comfort.

- Inverter (RZF-C series)
- Conventional inverter (RZR-L series)
- Non inverter

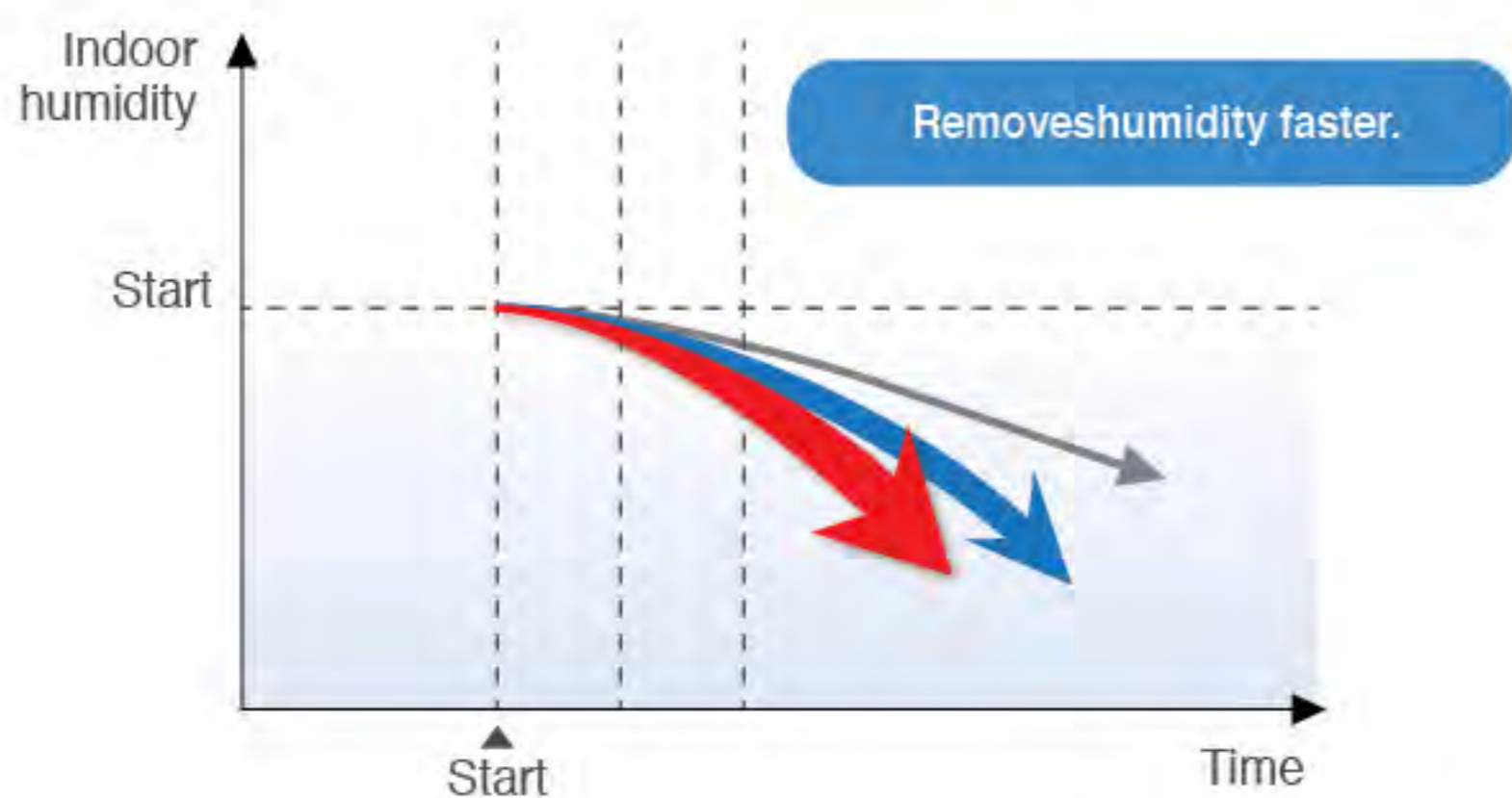
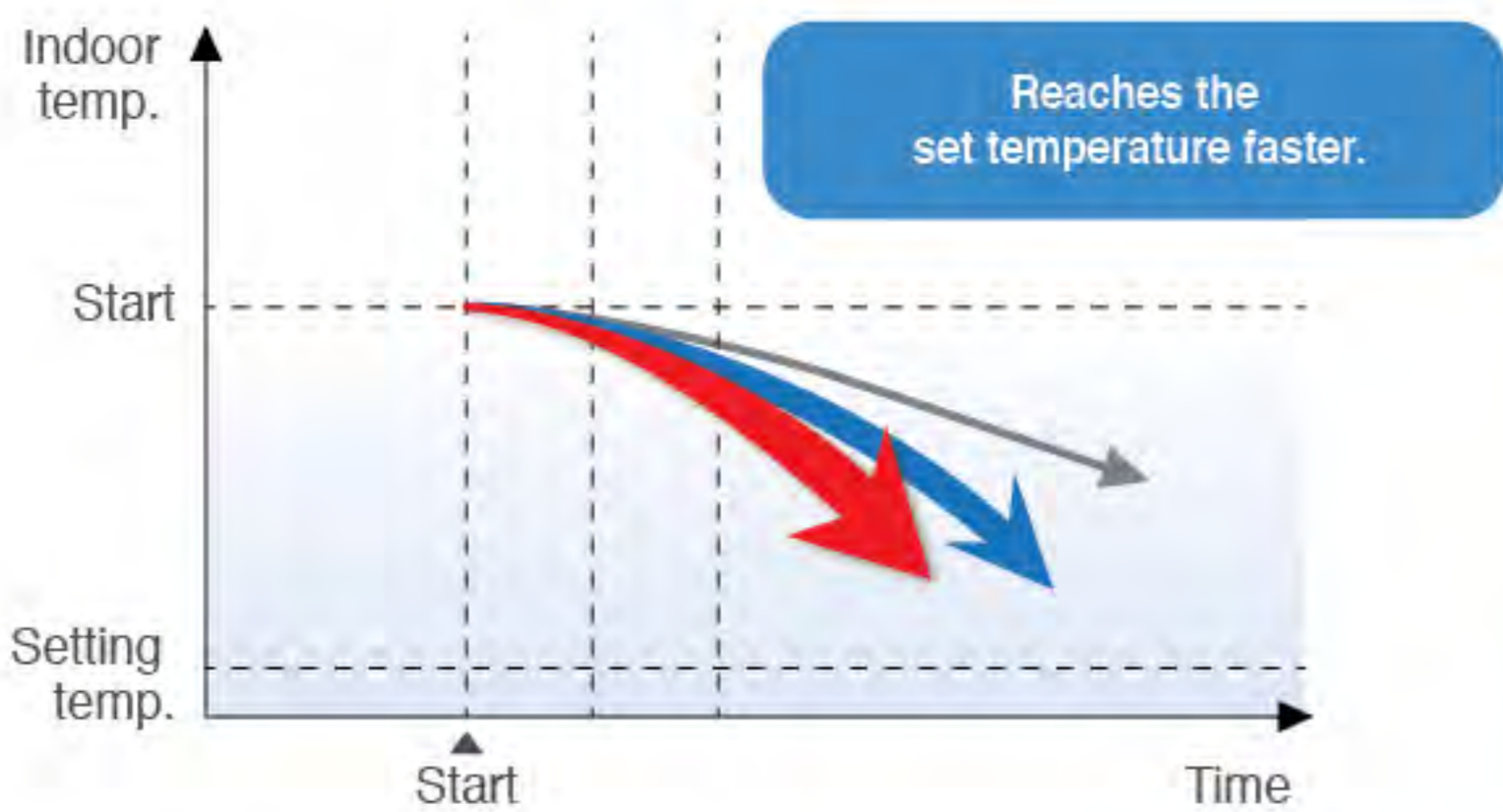
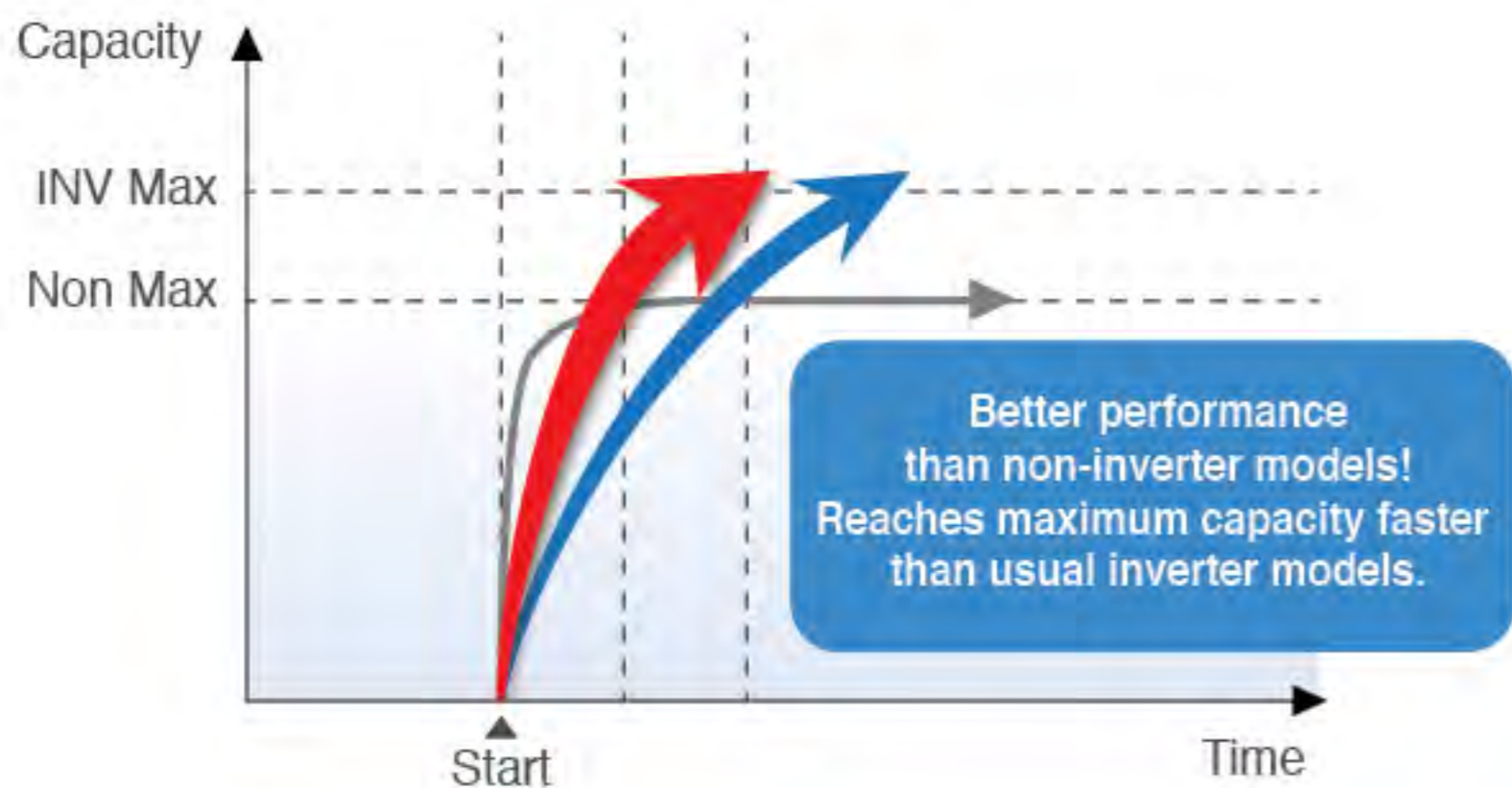

◆ Quick start function

RZF series

Quickly make space comfortable before the arrival of office workers or shop customers.

The airflow rate of indoor unit is automatically controlled, increasing the capacity of the outdoor unit and quickly bringing the room to a comfortable temperature.

This function will operate for a maximum of 30 minutes until the air conditioner automatically returns to normal operation.



- BRC1E63 wired remote controller is used for 'Quick start'.



Smart Airflow Control

- ◆ Indoor units can provide 5-step and 3-step fine control of air volume

5-step: FCF and FAFC series

3-step: FCFC, FFFC, FBFC, and FHFC100-140 series

- ◆ Comfort ensured by 'Auto' airflow rate that matches load level

*Except for FHFC50-71 series

Convenient energy-efficiency for stores with peak and quiet periods.

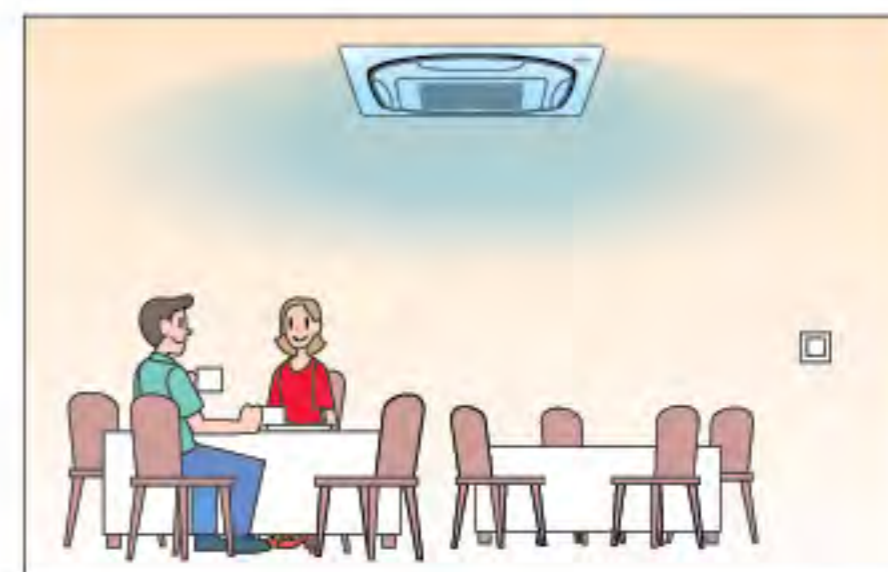
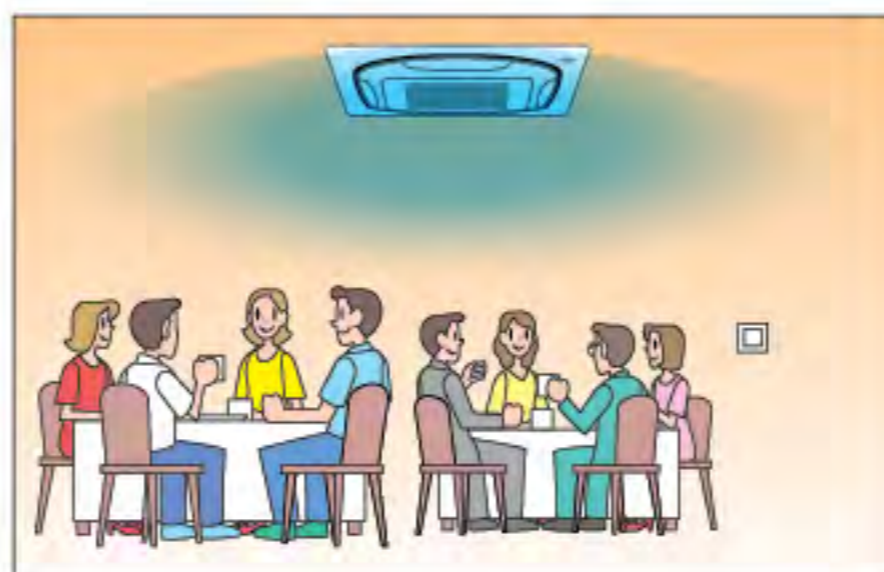

- ◆ Also convenient for high ceilings and spaces with long blow distances

Cassette type <Round Flow>:
maximum 4.2 m*

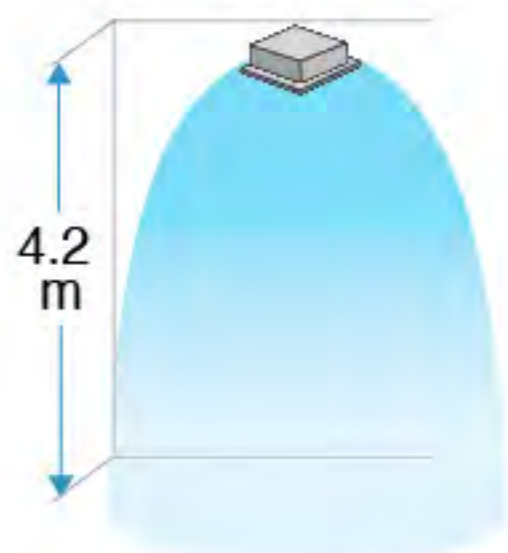

See page 25

Compact multi flow
ceiling mounted
cassette type

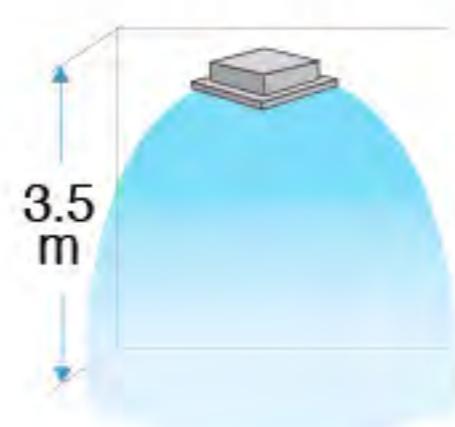

See page 30

*Maximum 4.2 m for FCF100/125, FCFC100-140
Maximum 3.5 m for FCF50-71

Ceiling suspended type:
maximum 4.3 m*

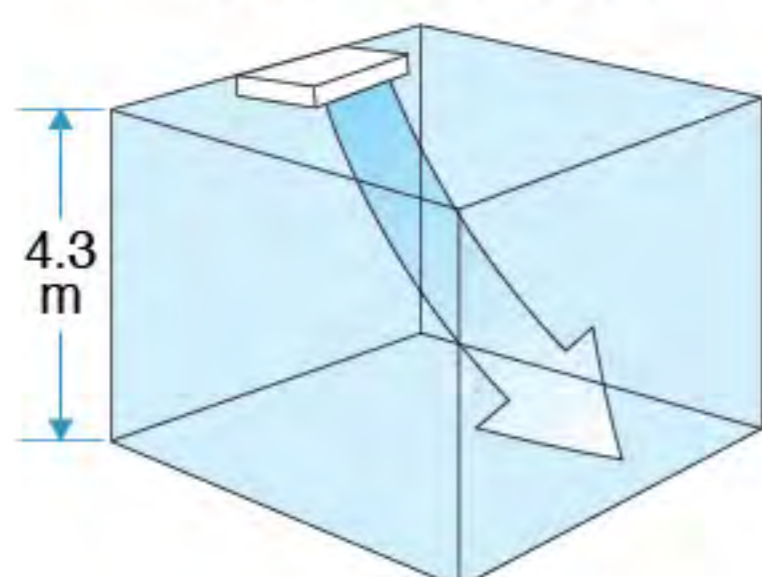

See page 34

*Maximum 4.3 m for FHFC100-140
Maximum 3.5 m for FHFC50-71

*Field setting with remote controller



Durability

◆ Microchannel heat exchanger

*Except for RZFC35

Microchannel technology utilises superior heat transfer benefits of aluminium to create a more efficient air conditioner.

With a new resistance corrosion aluminium alloy, the Daikin microchannel heat exchanger becomes highly durable.

A salt spray test has been conducted to demonstrate the corrosion-resistant capability of our products in corrosive environments for a certain period of time.

● Test of durability

- Testing organization MTEC Thailand
- Testing standard ASTM B117
- Result

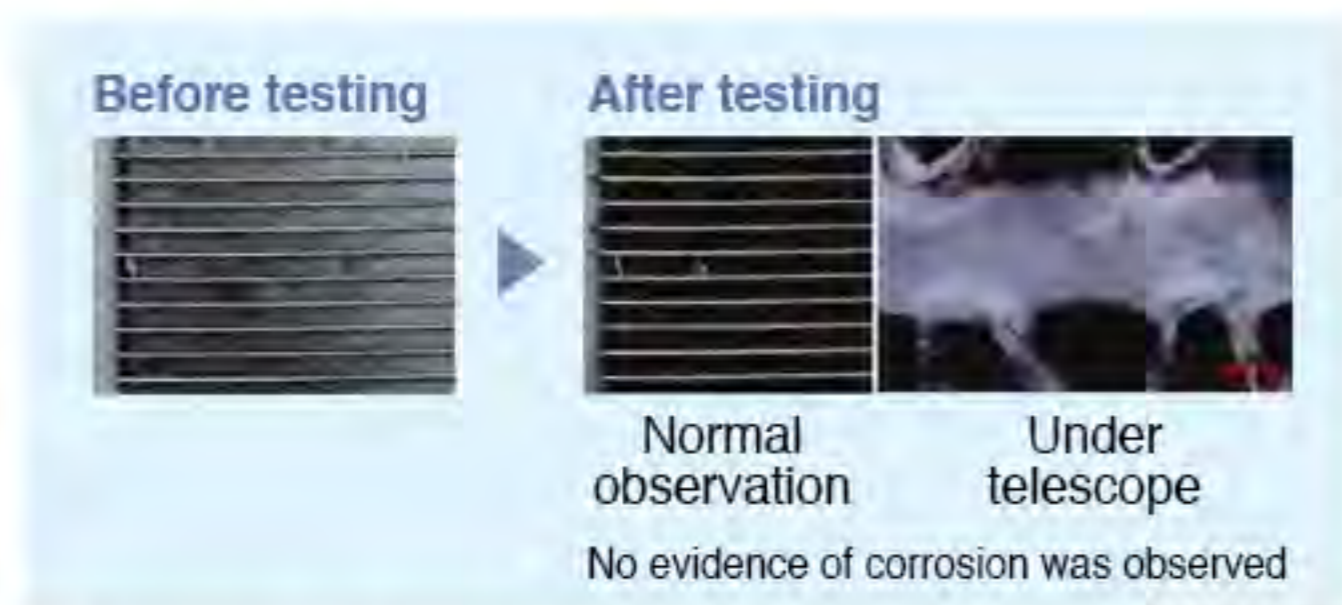

After undergoing an intensive test, the Daikin microchannel heat exchanger is able to maintain its shape without corrosion, which strongly confirms its durability in a highly corrosive environment.

◆ Overvoltage PCB (Outdoor unit option)

RZF series

Page 64

Unstable power supply is a common problem in many regions. It can cause overvoltage which can significantly damage electronic devices.

To prevent voltage fluctuations, it is usually necessary to attach a stabiliser when installing an air conditioner.

The RZF-C series is equipped with a highly-durable electronic circuit.

This circuit eliminates the need for a stabiliser and offer additional protection for devices in the outdoor unit, such as its fan motor and compressor.

◆ Coated printed circuit boards (outdoor unit)

Coated circuit boards prevent problems caused by humidity and airborne dust.

It also protects against salt contained in sea breezes. Both sides of the PCB in outdoor units are coated.



◆ Automatic protection against low voltage

In AM and PM peak electricity consumption periods, supply may fluctuate. Built-in low-voltage protection will automatically cut operations. When normal voltage is restored, operation will resume as before.

◆ Outdoor unit installation is possible even with limited space

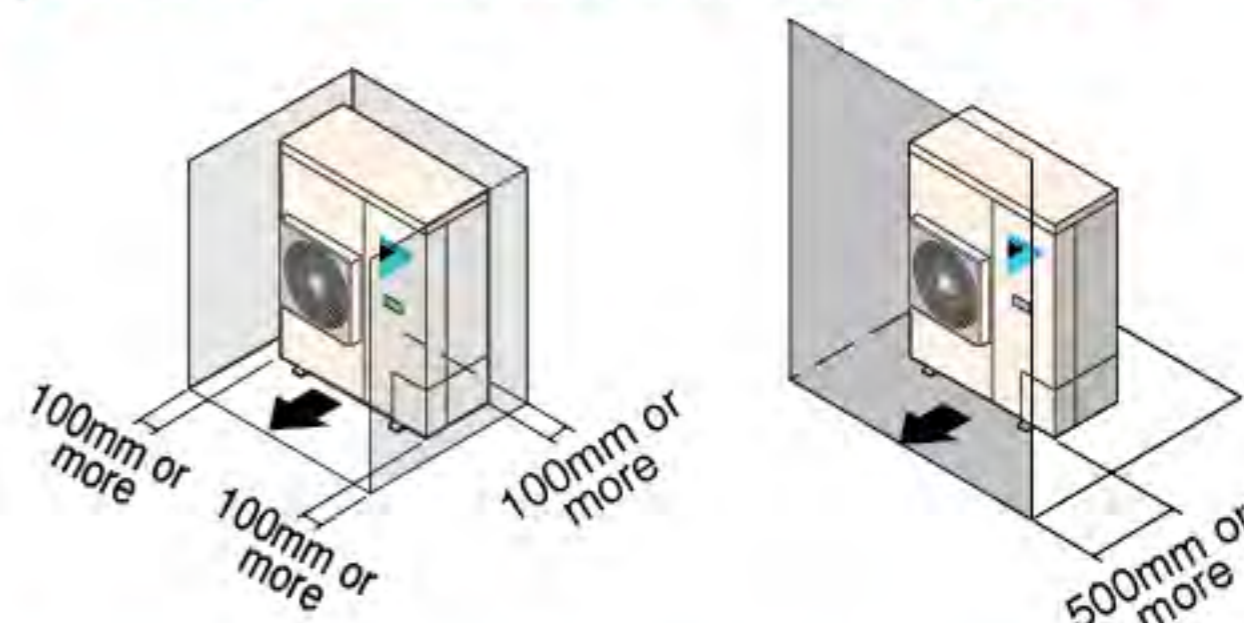

◆ Self-diagnosis functions enable prompt maintenance response

An error message appears on the LCD of the remote controller and an LED lights up on the unit.

When the BRC1E63 is installed, the error code appears showing contact information and model name. Contact your Daikin dealer and provide the error code and model name.

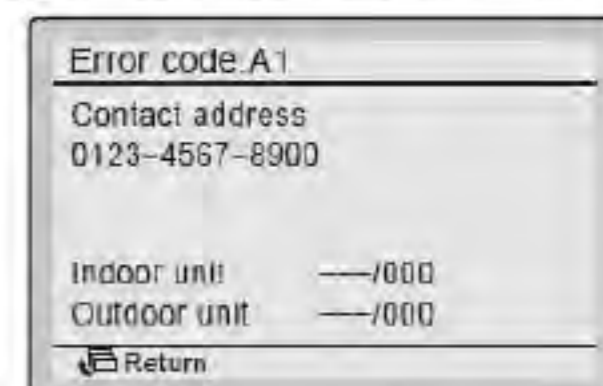
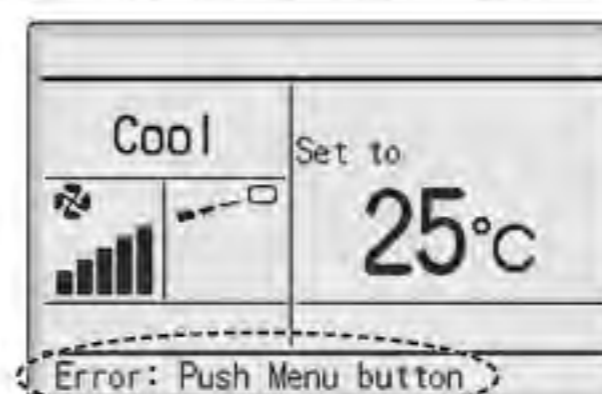

Convenient Functions

Navigation remote controller BRC1E63 includes various convenient functions

Automatic return to temperature preset by owner.

Owner can preset upper and lower temperatures.

● Setpoint auto reset

- Even if the set temperature is changed, the new set temperature returns to the previous preset value after a preset duration of time.
- Period selectable from 30, 60, 90, or 120 minutes.

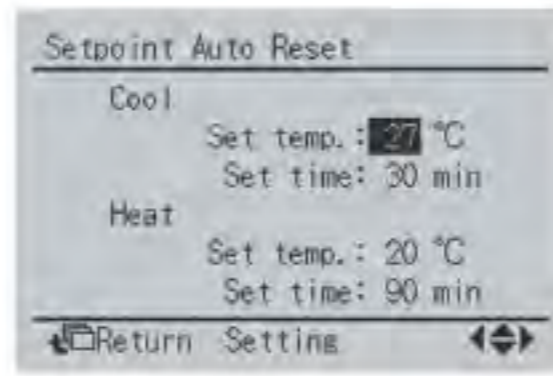

● Setpoint range set

- Saves energy by limiting the min. and max. set temperature.
- Avoids excessive heating or cooling.
- This function is convenient if the remote controller is installed where anyone can change the settings.

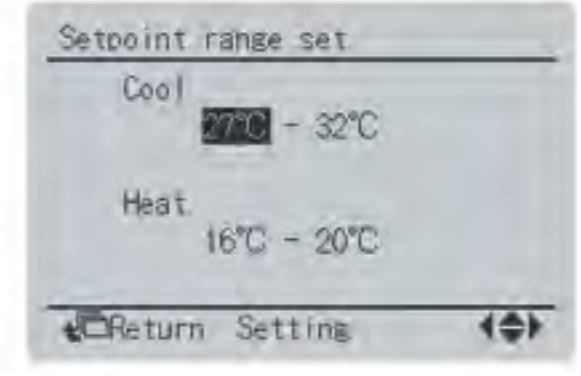

Restaurant example

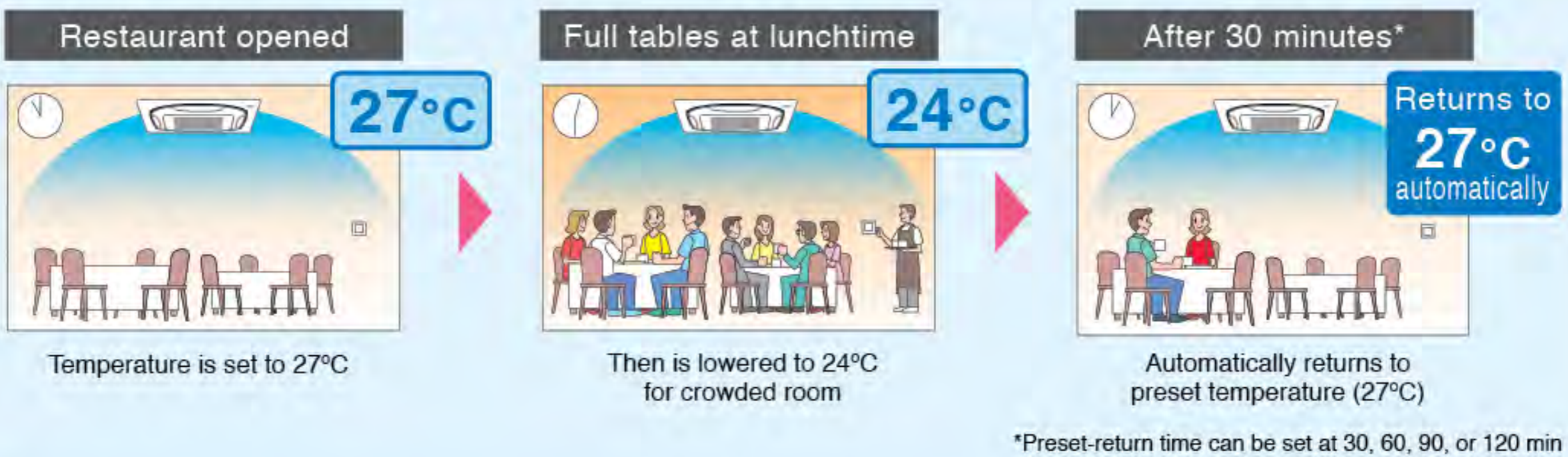

◆ Demand control function

RZF100/125

By setting limits that restrict power consumption, you can cut electricity bills.

- Power consumption is given first priority, and limits maximum power consumption of unit.
- Maximum power consumption can be set at 40, 60, 70, 80, or 100%.

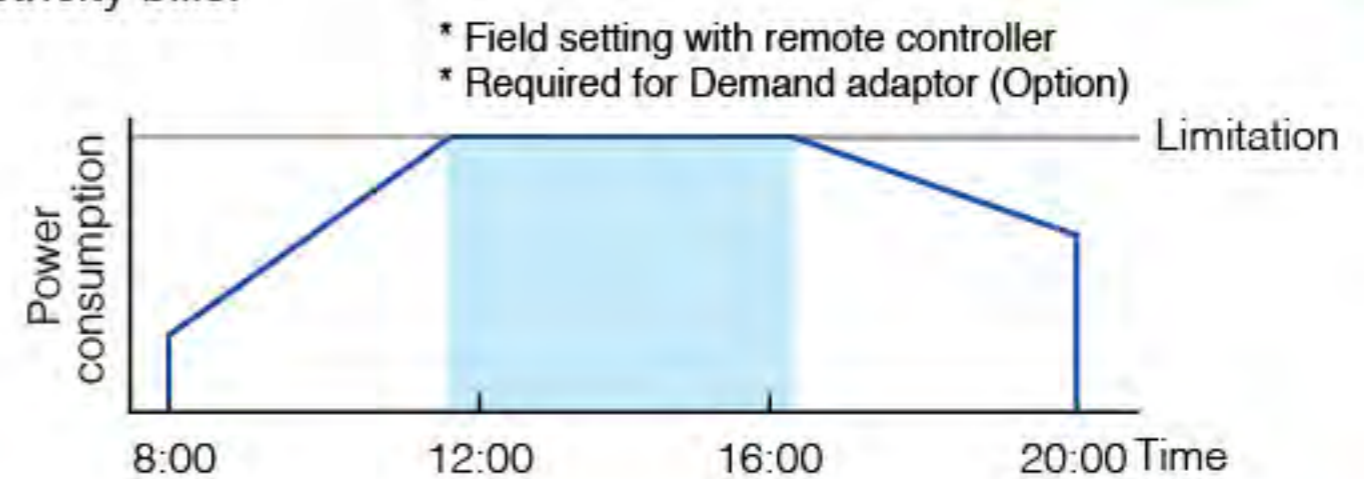

◆ Night quiet operation mode

RZF series

Consideration is given for people living nearby. Outdoor unit operating sound can be reduced.

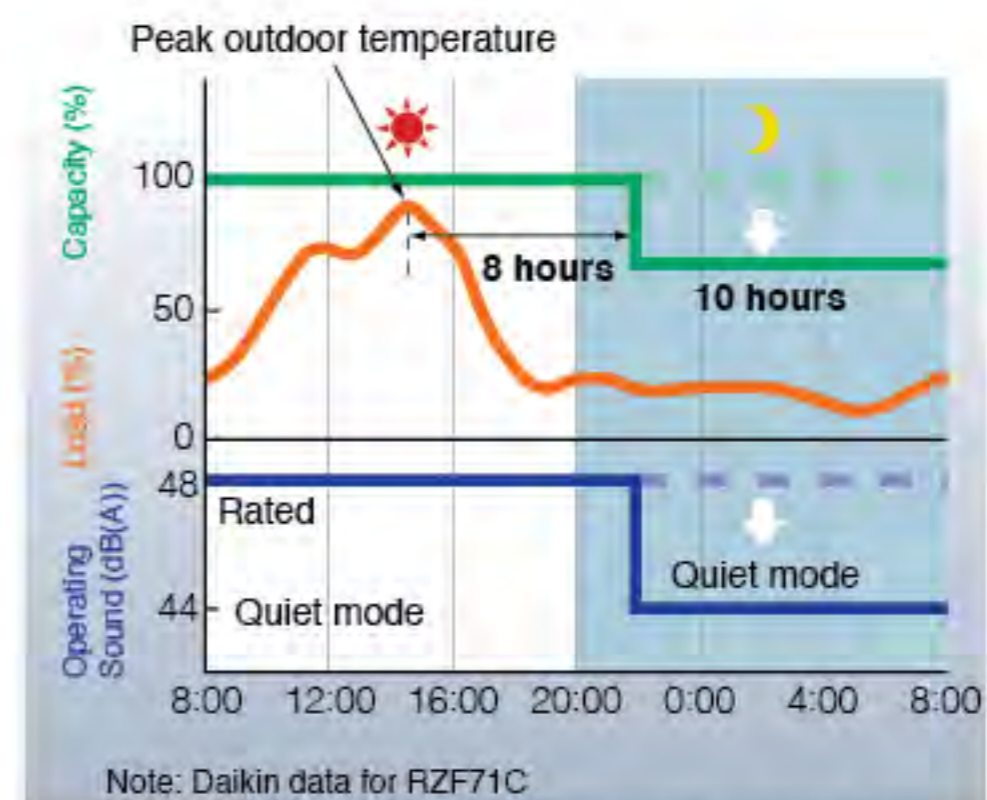

Operating sound about 4 dB quieter

Design Flexibility

◆ Possible to forced OFF and ON/OFF operation using external command

*Field setting with remote controller
*Except for FHFC50-71 and FAFC series

Round flow cassette type

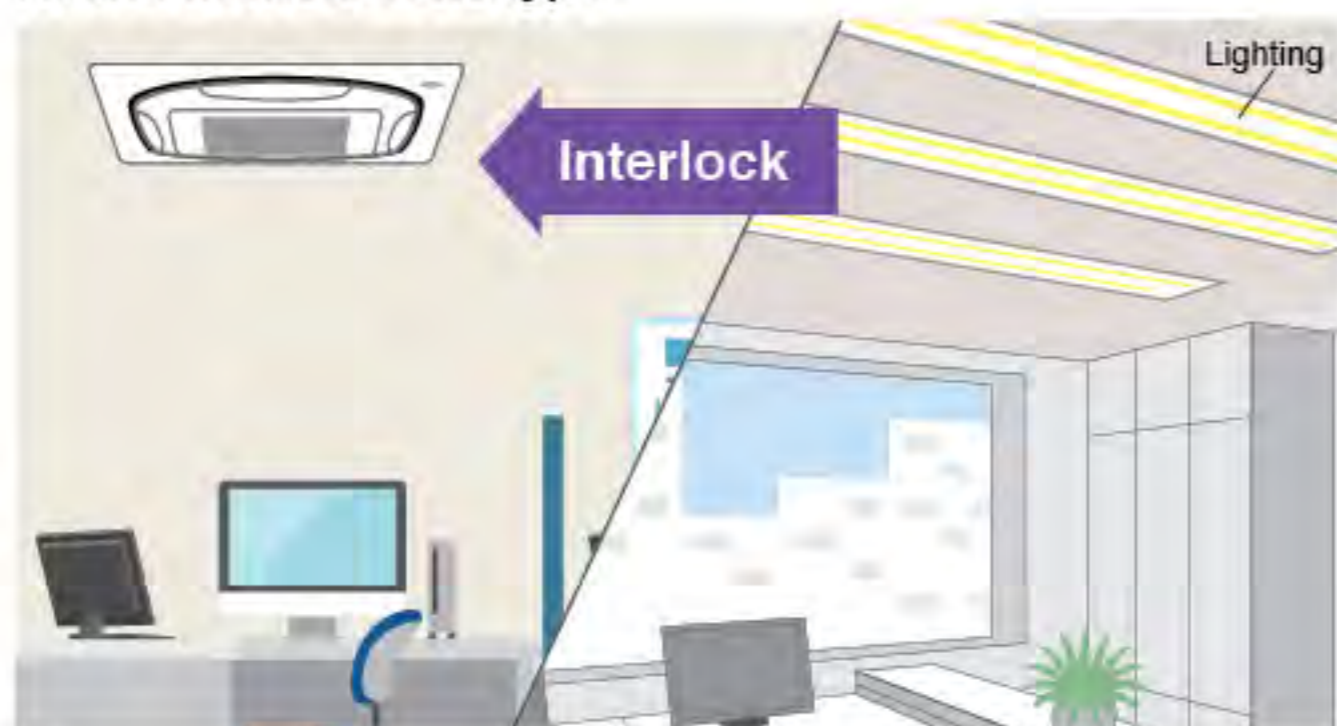

Duct connection middle static pressure type



◆ External Equipment Interlock (FCF-C series only)

RZF series

Power conservation is possible through interlock* of external equipment, such as lighting, with the infrared presence sensor.

*Optional adaptor for wiring: BRP11B62 is necessary.

Human presence is detected by the built-in infrared presence sensor in the sensing panel, and the presence detection signal can be output and interlocked with external equipment such as ventilation and lighting equipment.

Sensor interlock mode

The presence detection signal of the infrared presence sensor can turn only external equipment ON/OFF without interlocking with air conditioner operation/stop (ON/OFF).

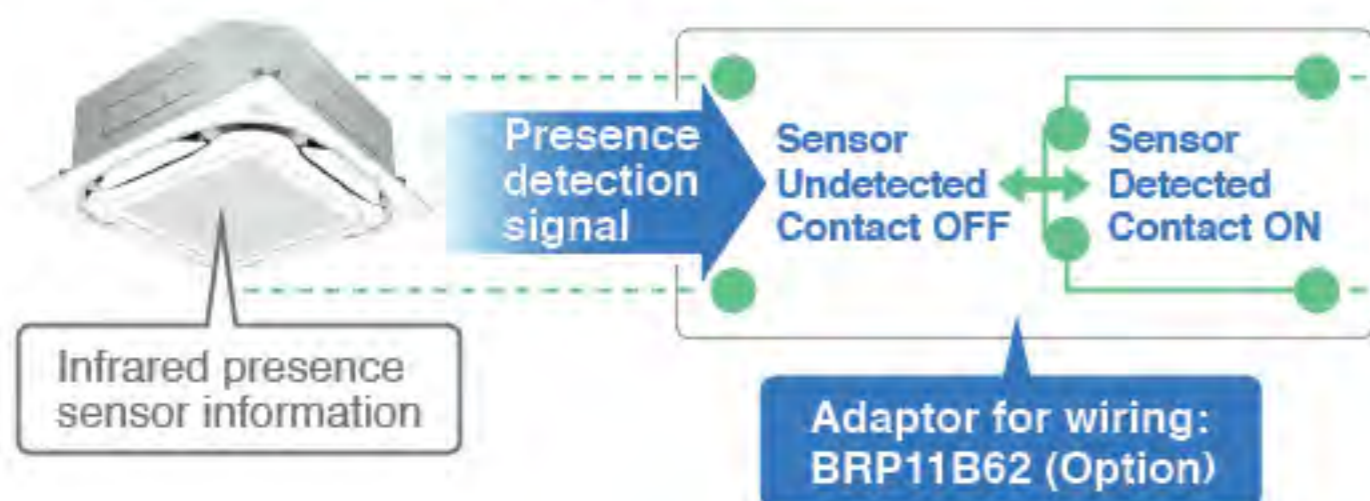

Note:
When the presence detection signal is output to external equipment using the adaptor for wiring, other functions, such as interlock with the duct booster fan and the output of other signals, become disabled.

◆ Indoor units (FCF, FCFC, FFFC, FBFC and FHFC100-140 series) comply with DIII-Net standards

*FHFC50-71 series requires optional adaptor to connect DIII-Net.
FAFC series cannot connect DIII-Net.

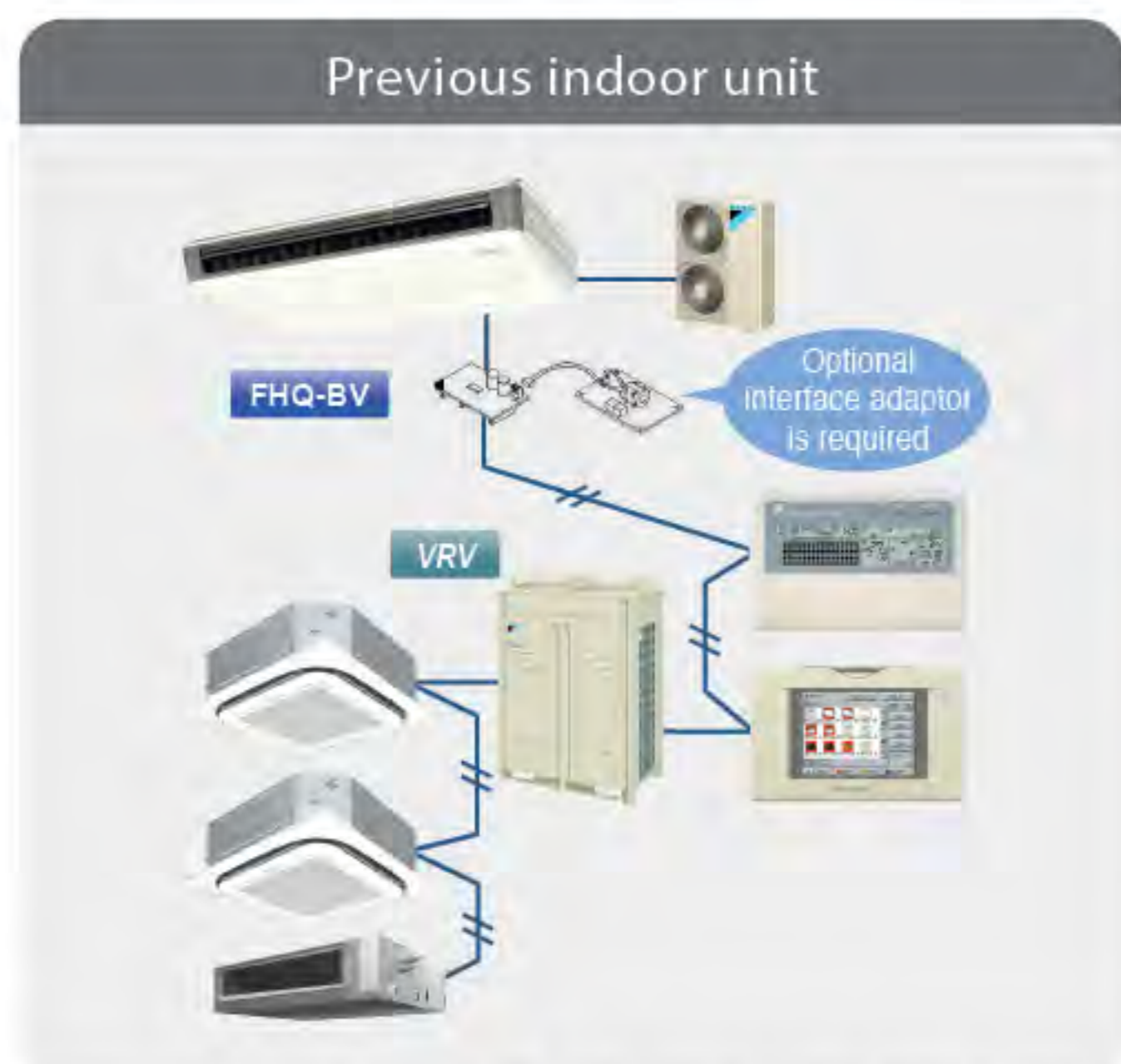

Easy connection to DIII-NET and long piping length makes this solution suitable for projects including VRV and SkyAir.

Benefit 1

◆ Simplified installation reduces replacement time and cost

When considering air conditioner replacement, do the following things concern you?

- The length of time the business will be closed
- Effect on sales during replacement work
- High costs and long work period due to scaffolding needed for pipe replacement

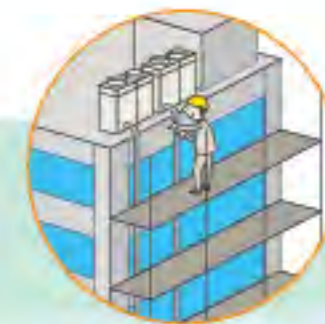

These problems are **solved by Daikin!**

Where feasible, we reduce work costs and time by reusing existing pipes*.

*Strict conditions apply, please check the table on page 38 for acceptable pipe sizing (if pipes are to be reused).



Benefit 2

◆ You can increase cooling capacity

Upgrade to an air conditioner with the latest technology for greater comfort and energy efficiency.



As a result, the greater capacity units ensure better performance to cope with the increasing amount of heat generated by office equipment and occupants.

◆ Technology

Advanced technology, including the use of corrosion resistant electronic expansion valves, acid neutralisers and improved compressor reliability, enables the re-use of existing piping* without the need of pipe flushing for a simplified replacement process.

Stronger refrigerating machine oil

An acid neutraliser agent is added to disable acids (chlorine ions), which cause corrosion.

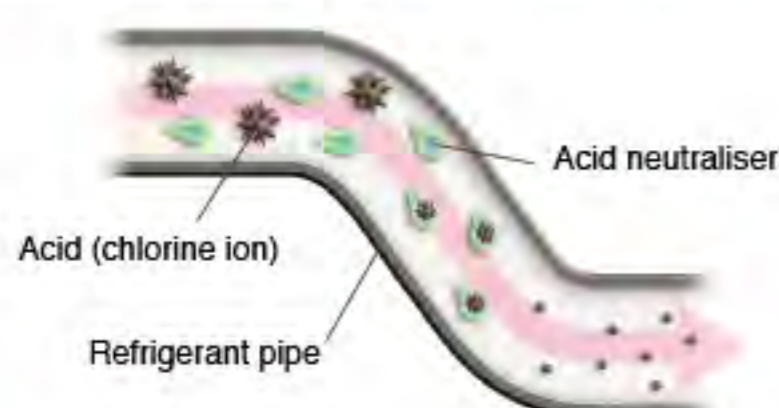

Highly corrosion resistant electronic expansion valve

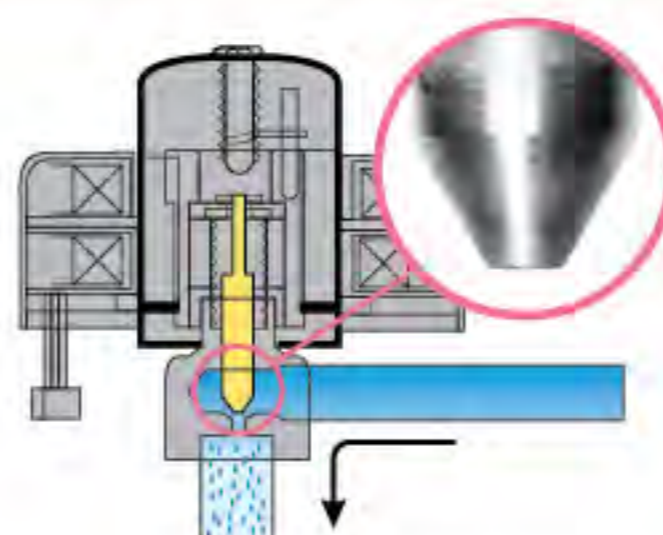







Highly reliable compressor

Compressor durability is improved by installing a filter or accumulator to collect solid foreign substances.



Detail of Each Product Specification

<p>CEILING MOUNTED CASSETTE TYPE <Round Flow></p>	<p>FCF-C series FCFC-D series</p> 	<p>Page 22</p>
<p>COMPACT MULTI FLOW CEILING MOUNTED CASSETTE TYPE</p>	<p>FFFC-A series</p> 	<p>Page 34</p>
<p>DUCT CONNECTION MIDDLE STATIC PRESSURE TYPE</p>	<p>FBFC-D series</p> 	<p>Page 36</p>
<p>CEILING SUSPENDED TYPE</p>	<p>FHFC-D series</p> 	<p>Page 38</p>
<p>WALL MOUNTED TYPE</p>	<p>FAFC-A series</p> 	<p>Page 40</p>
<p>OUTDOOR UNIT</p>	<p>RZF series RZFC series</p> 	<p>Page 42</p>
<p>REMOTE CONTROLLER</p>		<p>Page 44</p>

Cassette air conditioner with 360° uniform airflow sets the standard



FCF50/60/71/100/125CVMG
FCFC100/125/140DVMG

*Shown above is FCF50-71.

Option Accessory required for indoor unit.

Wired Remote Controller

- Stylish Remote Controller (Wired) *1 (Option)



BRC1H61W (White)

BRC1H61K (Black)

- Navigation Remote Controller (Wired) *1 (Standard)



BRC1E63

- Simplified Remote Controller (Wired) *1 (Option)



BRC2E61

Wireless Remote Controller

- Wireless Remote Controller *2 (Standard)



Cooling only
BRC7M635F (Fresh white)
BRC7M635K (Black)

Signal receiver unit (Installed type)

Wireless remote controller is supplied in a set with a signal receiver.

Note: *1 Remote controller cable is not included and must be obtained locally.

Note: *2 A signal receiver must be added to the indoor unit.

Panel Variations



Standard panel with Sensing (Fresh white)



Standard panel (Fresh white)



Designer panel (Fresh white)



Standard panel with Sensing (Black)



Standard panel (Black)



Auto grille panel (Fresh white)

FCF	Specification	Option
	P.56	P.60

FCFC	Specification	Option
	P.56	P.62

P.24-25

Circulation Airflow

Cools the entire room to deliver comfort that never feels cold.

The illustration shows typical airflow. Effectiveness may differ according to room conditions, room size, and distance to walls.



Featured video at Daikin Official YouTube Site



P.26-27

Individual Airflow Direction Control

Airflow direction can be individually adjusted for each air discharge outlet to deliver optimal air distribution.



P.27-29

Sensing Technology

Dual sensors and individual airflow direction control automatically provide optimal control of airflow.

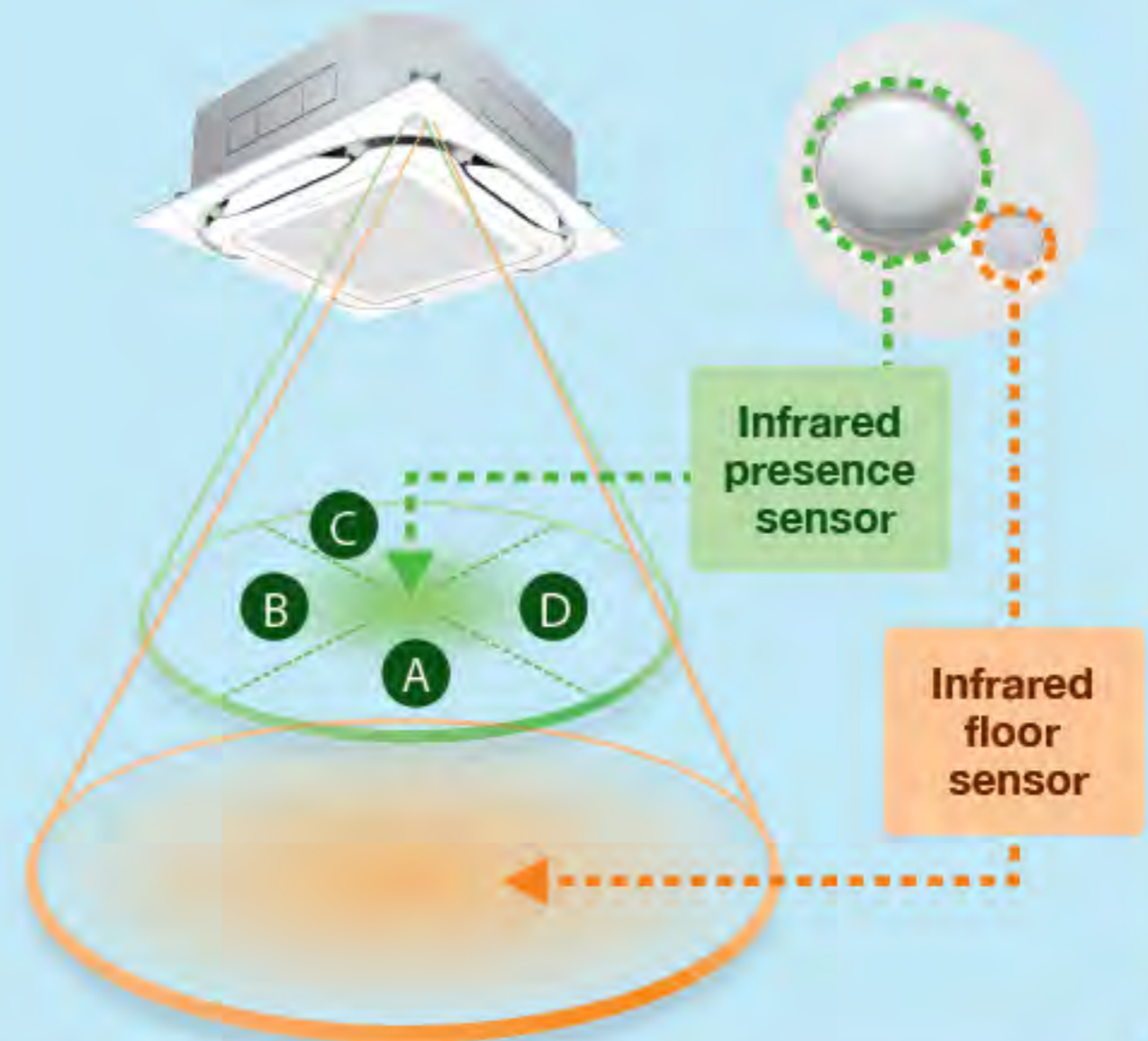

Selectable Airflow Pattern

Because air flows out from corner outlets, comfort spreads more widely.

Typical flow patterns

There are a total of 18 flow patterns.

All-round flow

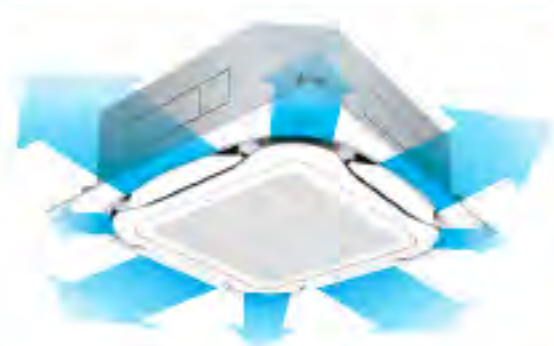

(E.g., installed in middle of ceiling)
4-way flow also possible.

3-way flow



(E.g., installed near a wall)

L-shaped 2-way flow

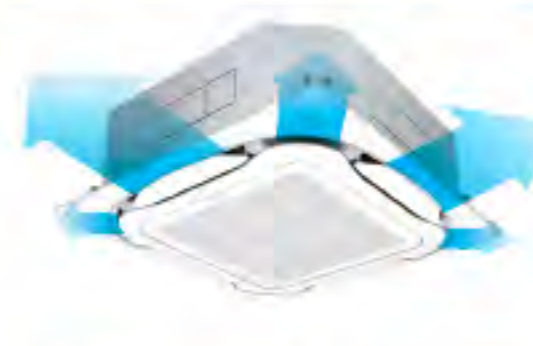

(E.g., installed in a corner)

Opposite 2-way flow

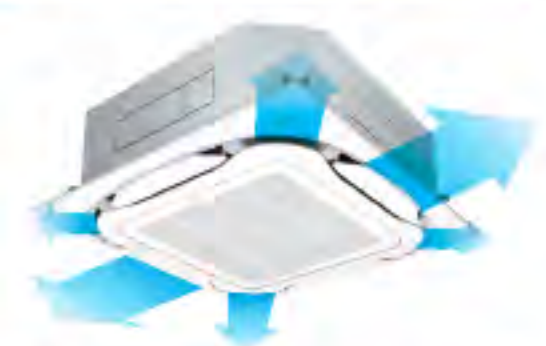

(E.g., installed in a long room)

Required distance to wall surface for closing air discharge outlet

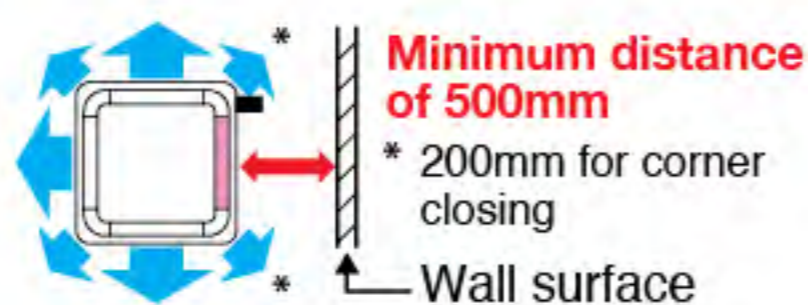

Note:

- Whatever the discharge direction, the same type of panel is used. If installing for other than all-round flow, an air discharge outlet sealing material (option) must be used to close each unused outlet.
- Operation sound increases when using 2-way or 3-way flow.
- Designer panel cannot operate 2-way and 3-way flow.

Circulation Airflow Evenly Distributes Cool and Warm Air *1

Airflow until now had

areas that were either too cool or not cool enough.



- Problem 1**
Hot outdoor air entering through windows and walls causes these areas to become hot.
- Problem 2**
Cool air accumulating directly underneath causes cold air pockets at floor level.
- Problem 3**
Airflow blowing directly on people causes discomfort for people in the room.
- Problem 4**
Quick descent of cool air causes insufficient cooling for corners of the room.

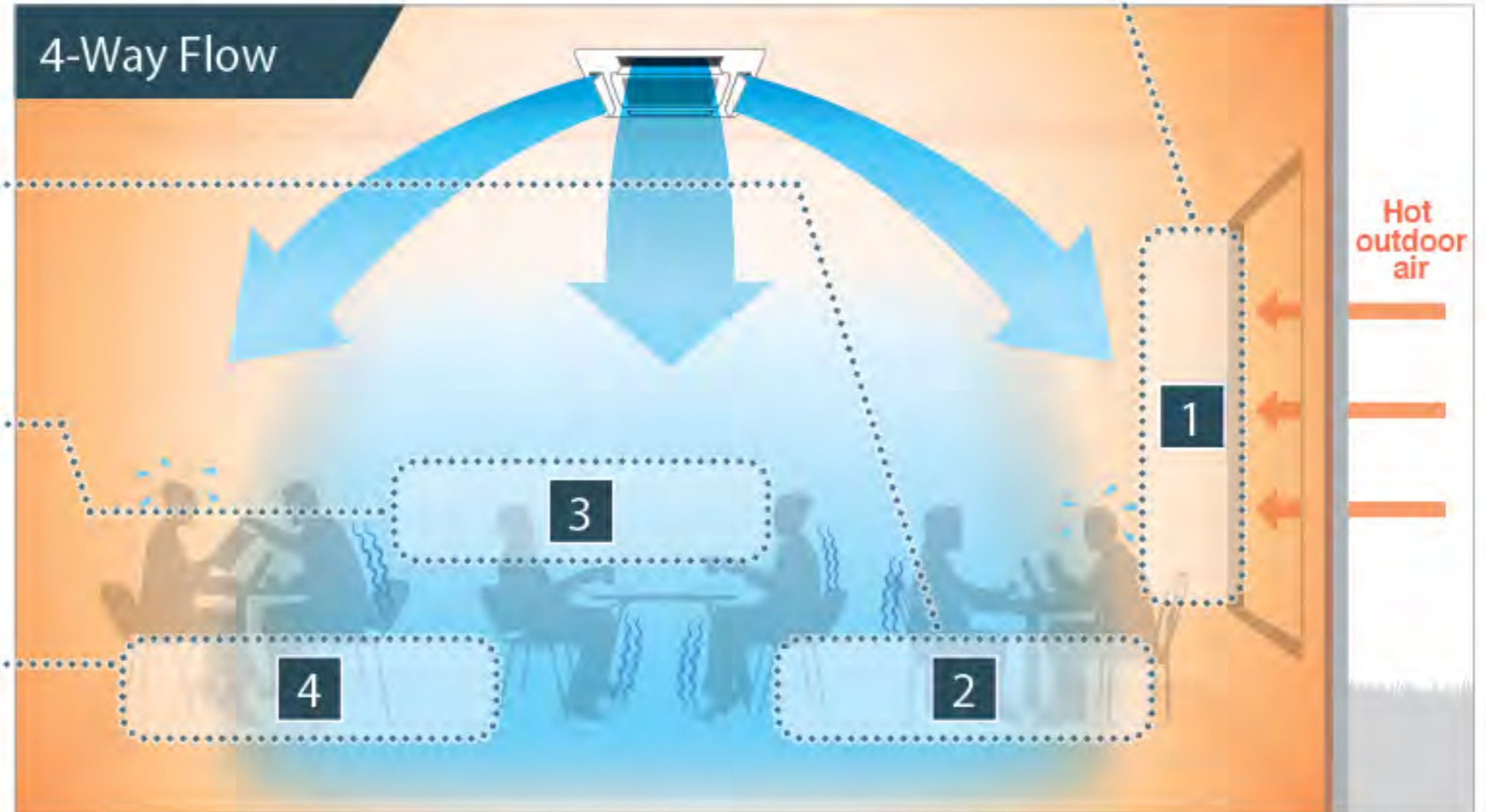

Circulation airflow cools the entire room to deliver comfort that never feels cold.

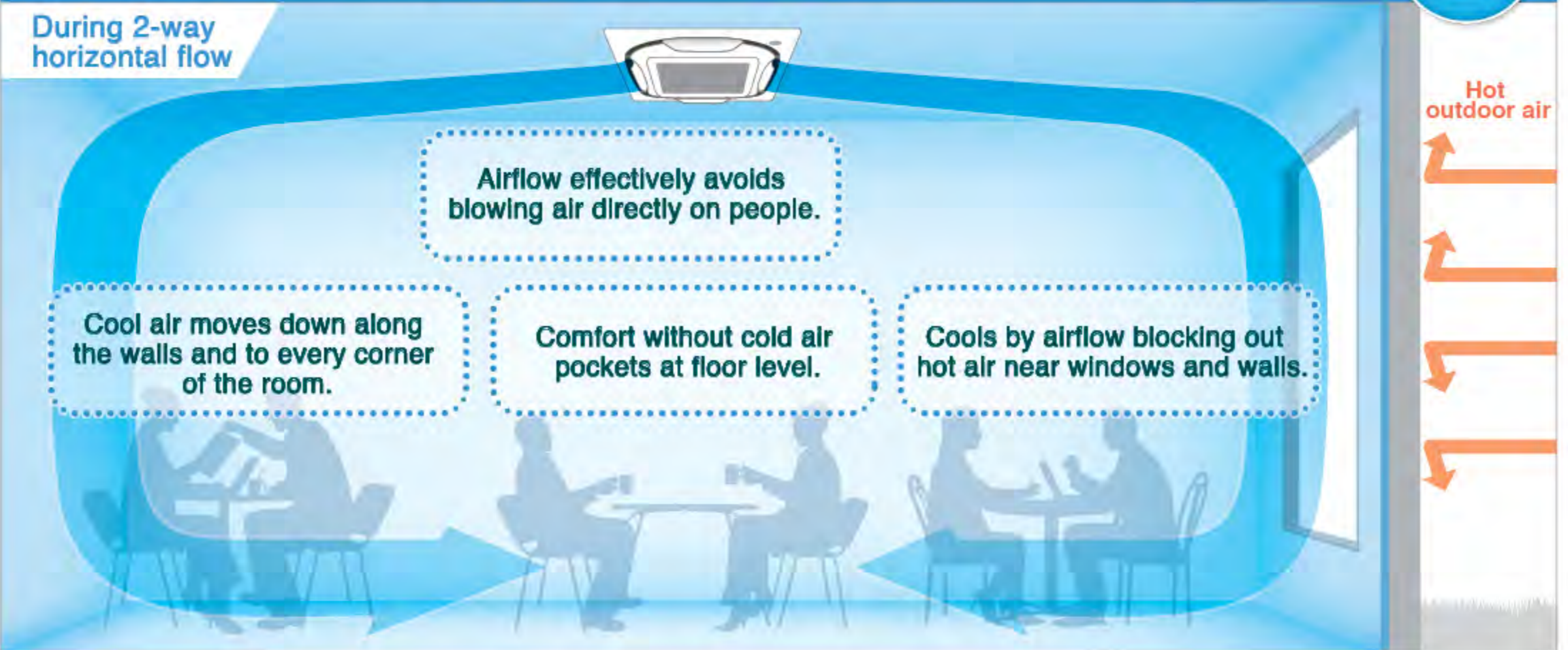

Configurations of Circulation Airflow (Cooling)

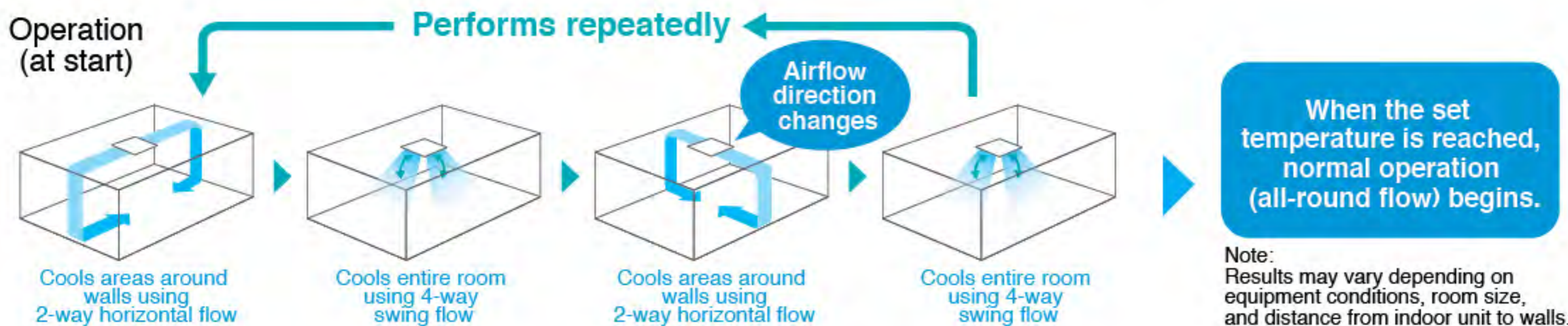

*1. Applicable when wired remote controller BRC1E63 is used.

Comfort to the Entire Room with Even Temperatures and No Cold Air Pockets at Floor Level

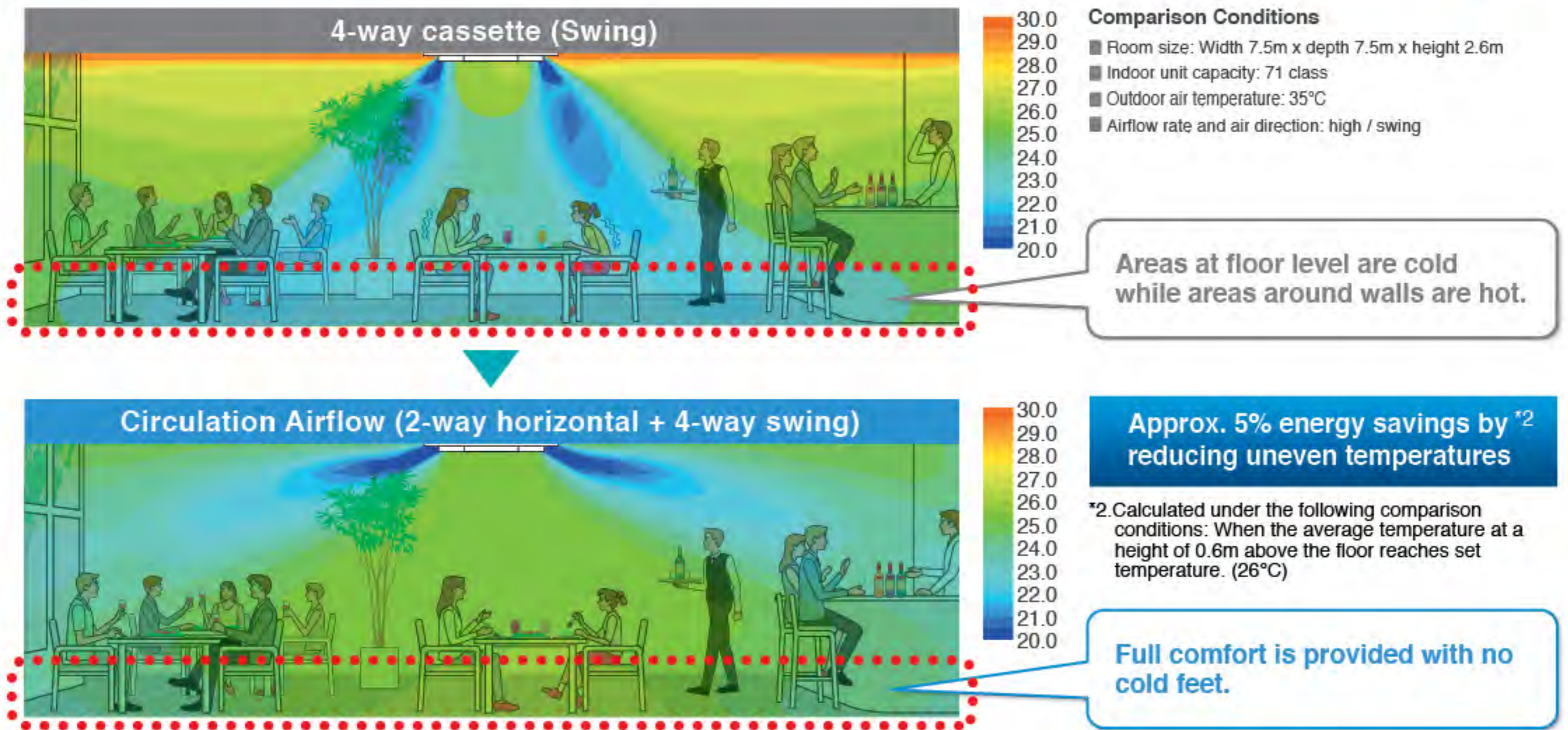

Three Technologies That Achieved Circulation Airflow

1 Use of new wide flaps (Straight)

With new, larger flaps, a straighter trajectory for airflow was achieved.

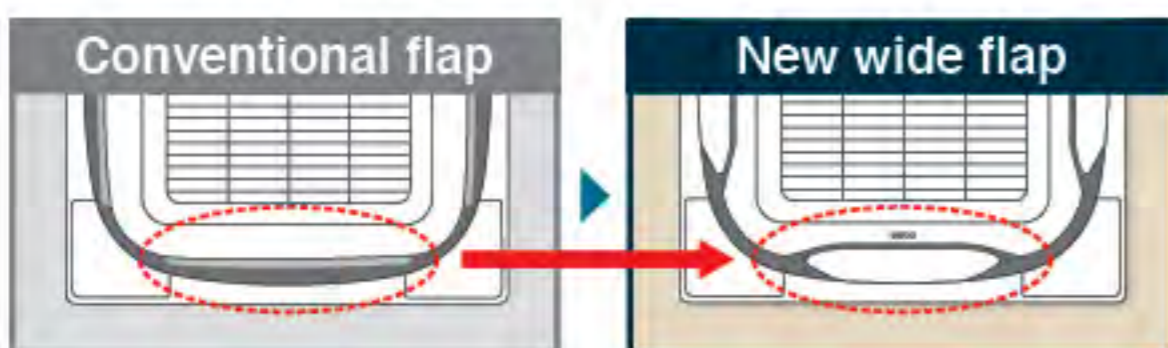

New wide flap construction inhibits ceiling dirt and grime.

By tapering both flap ends, the airflow that causes dirty ceilings is directed downward.

2 Optimizing airflow angle (Horizontally)

The airflow angle was made more horizontal.

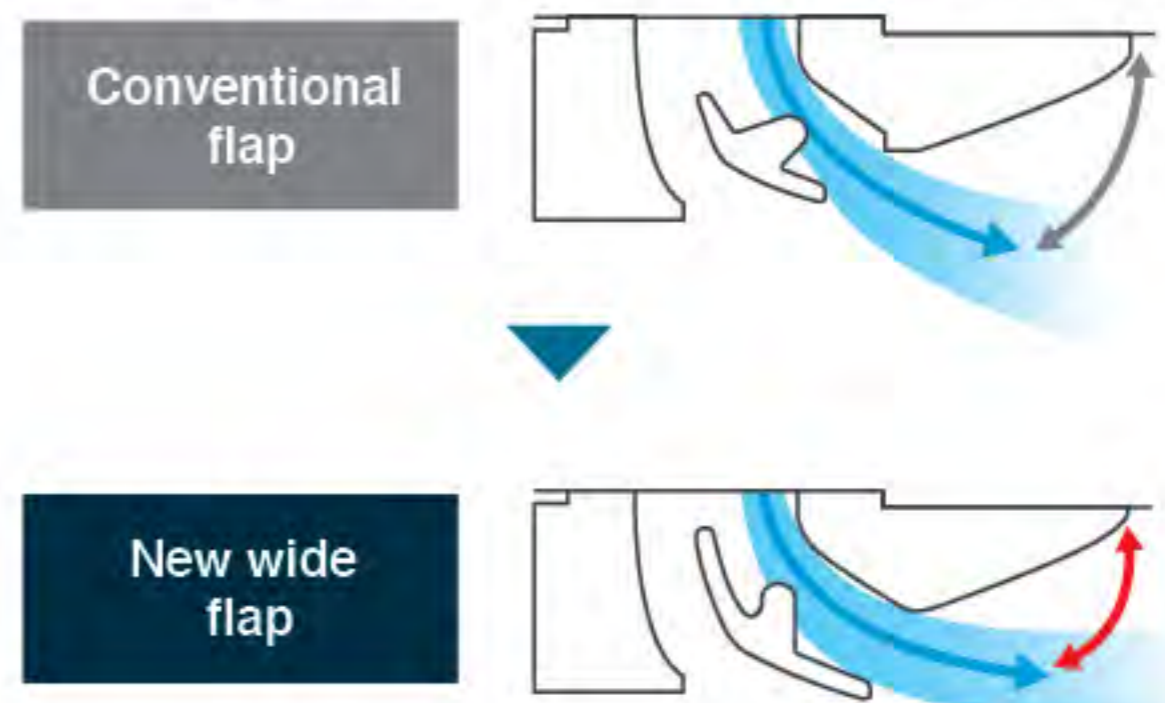

3 Increased velocity in 2-way flow (Strongly)

Airflow velocity is increased by up to 10% during 2-way flow.

*. Other 2 outlets are controlled by changing the flap direction (angle) to suppress airflow volume.

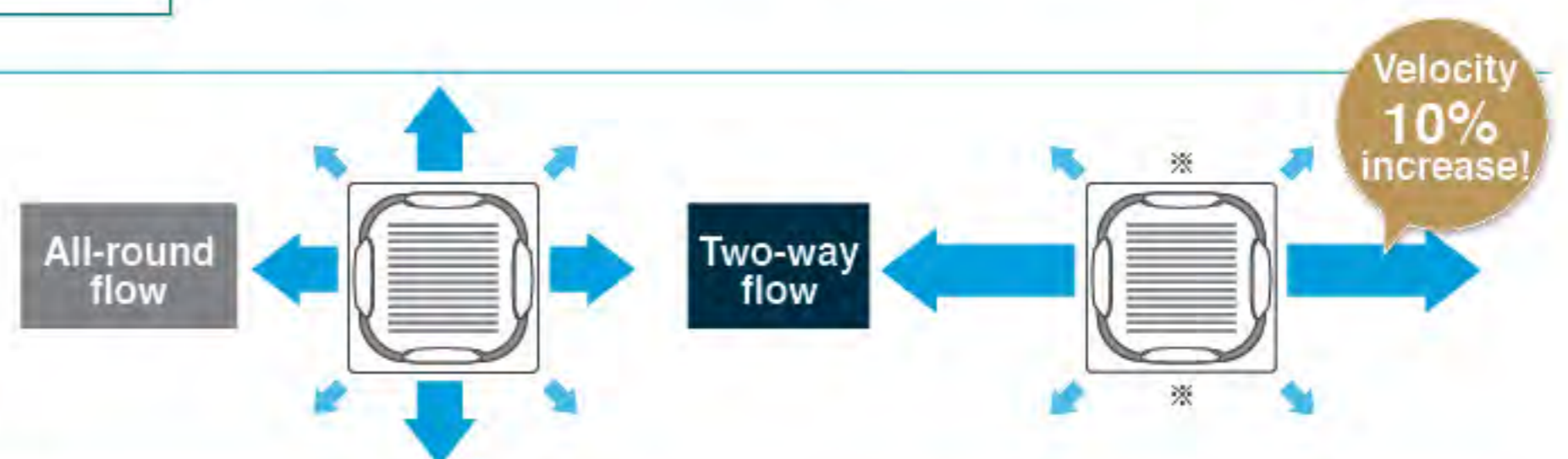

Things to remember when using circulation airflow

Main points for use

- Effectiveness may differ according to room conditions, room size, and distance to walls.
- Airflow operation differs when using the designer panel. (Operation repeatedly switches from 3-way horizontal flow to 4-way downward flow [swing] to 2-way horizontal flow to 4-way downward flow [swing].)
- Circulation airflow functions during connection with wired remote controller. (BRC1E63). However, use is not possible for the following conditions:
 - When a sealing material of air discharge outlet (for 2, 3, 4-way flow) and branch ducts are used;
 - When individual airflow setting is selected;
 - When using group control other than round flow.

Installation conditions

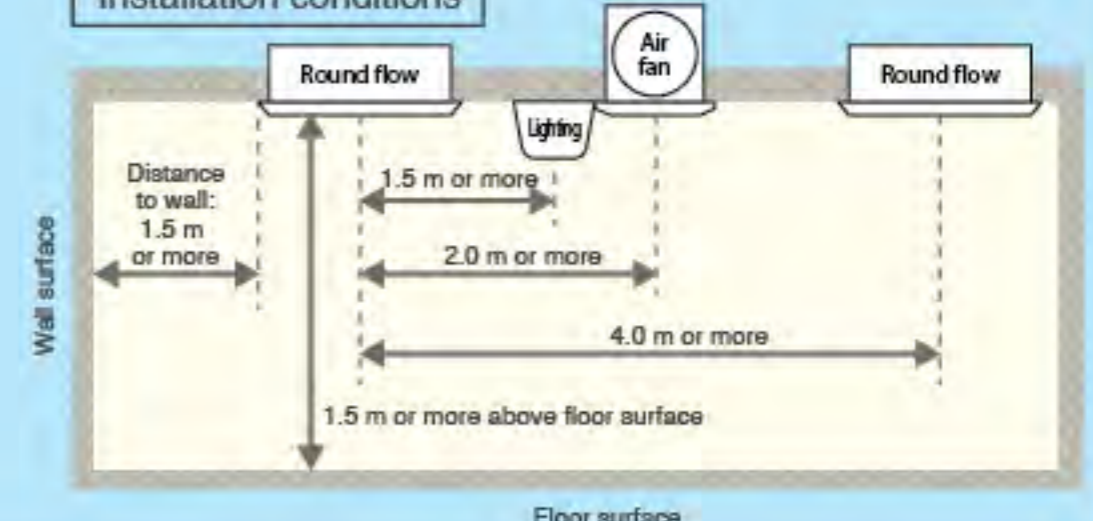

Individual Airflow Direction Control *1

*1. Applicable when wired remote controller BRC1E63 or BRC1H61W(K) is used.

Comfortable air conditioning for all room layouts and conditions

Airflow direction can be individually adjusted for each air discharge outlet to deliver optimal air distribution.

Easy setting is possible with a wired remote controller.

BRC1E63



Individual Settings List		
Outletmark	Air direc.	Indiv.
<input type="checkbox"/>	Position 0	ON
<input type="checkbox"/>	Auto	OFF
<input type="checkbox"/>	Position 4	ON
<input type="checkbox"/>	Swing	ON

Remote controller screen

There are identification marks near the air outlets.

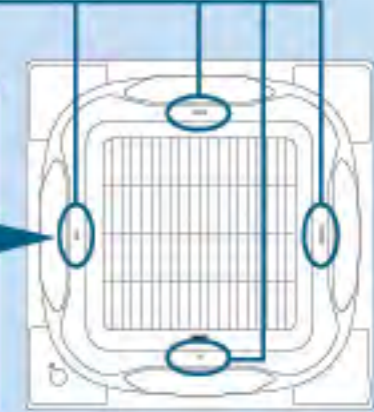

Position 0
(Fixed airflow to highest position)

No individual setting
(Auto airflow)

Swing
(Up/down)

Position 4
(Fixed airflow to the lowest position)

Individual airflow settings

- No individual setting (Auto airflow)
- Position 0 (Highest point)
- Position 1
- Position 2
- Position 3
- Position 4 (Lowest point)
- Swing

Individual settings are possible as stated above.

When individual airflow is selected, airflow direction can be adjusted to room layout.

■ For shops and restaurant

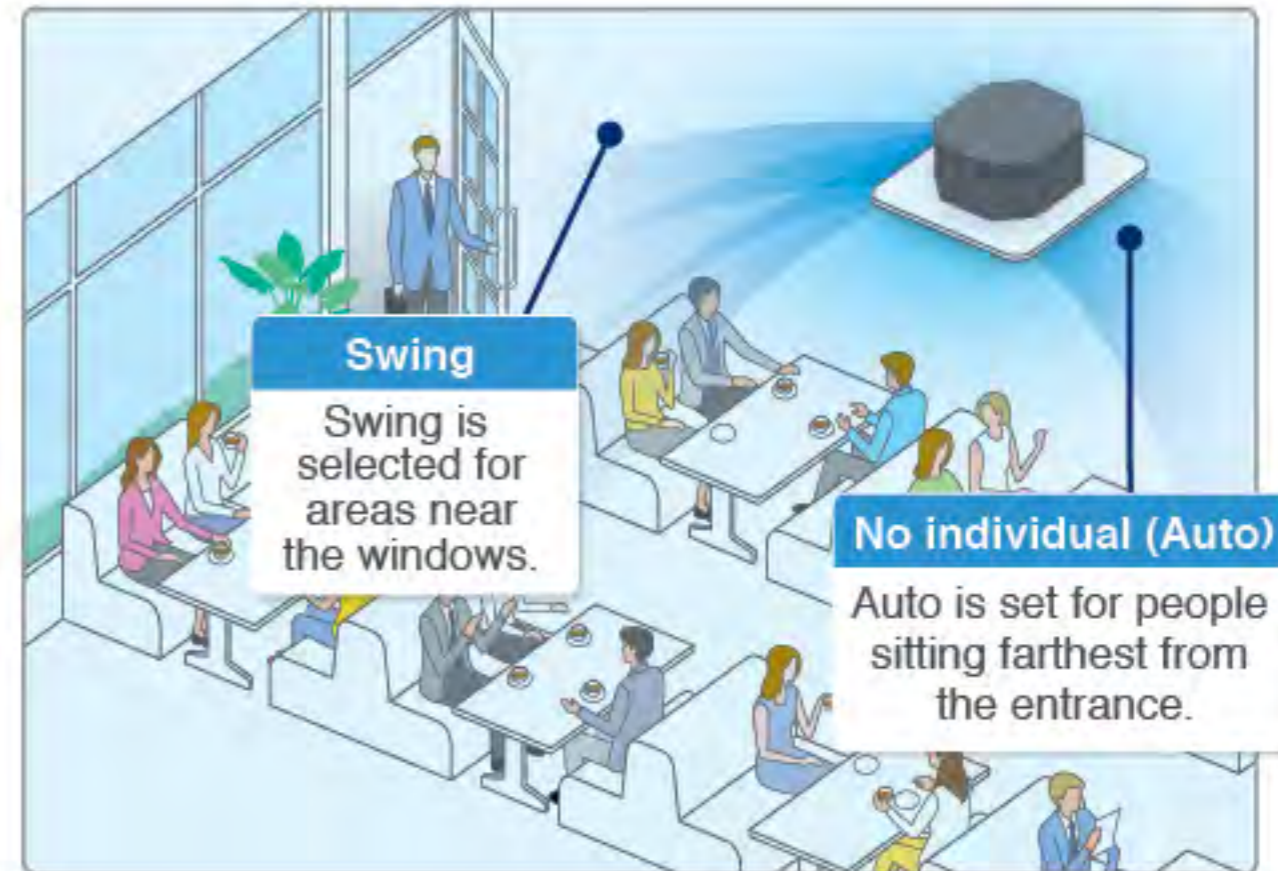
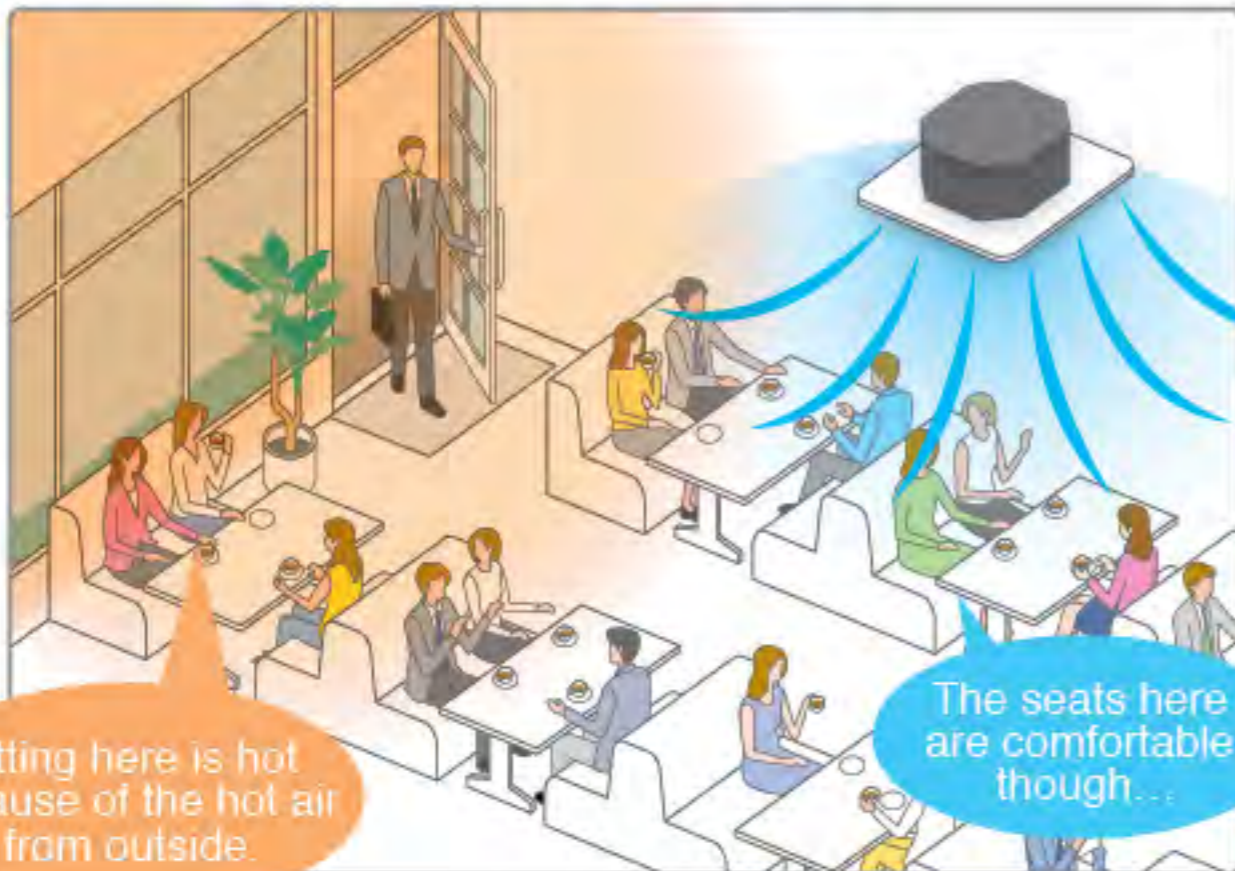

■ For offices

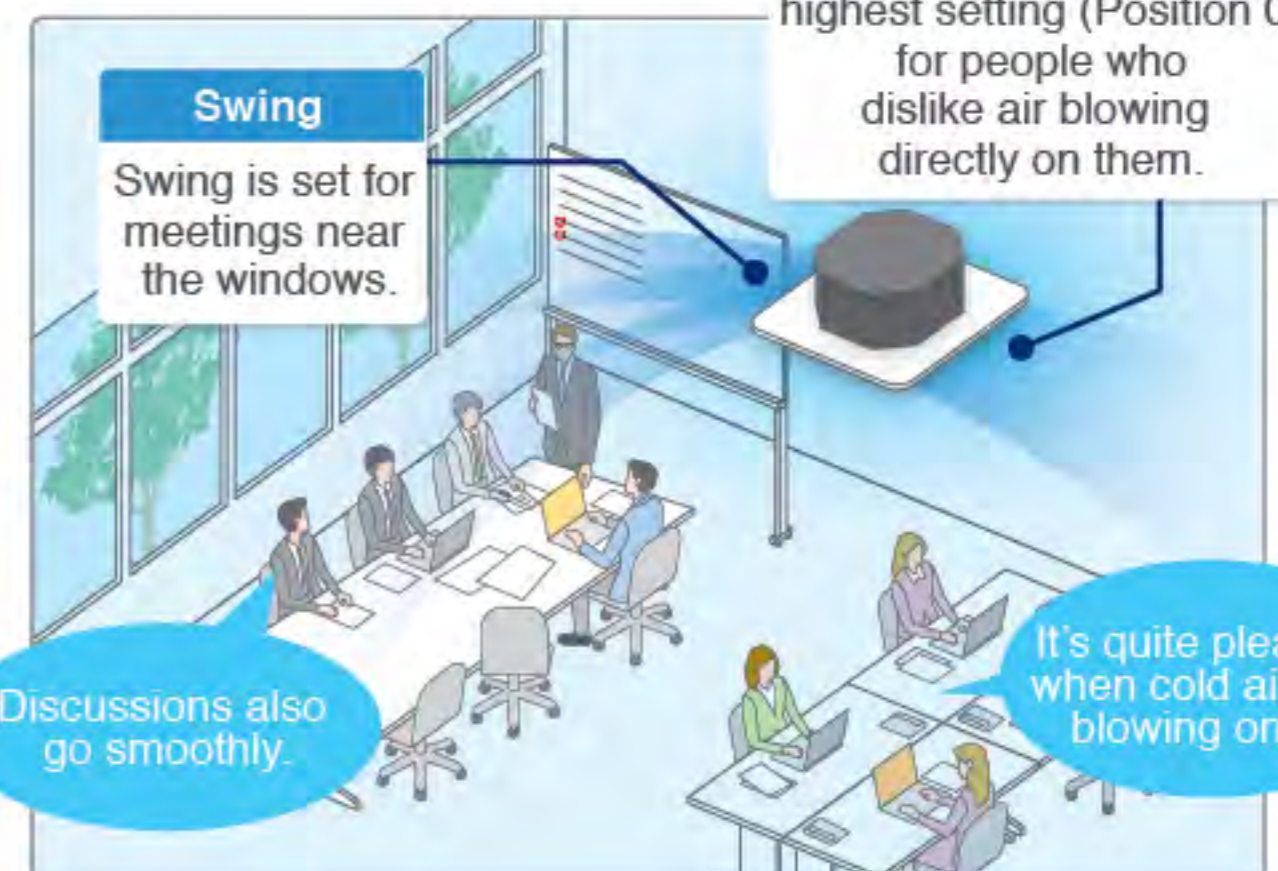
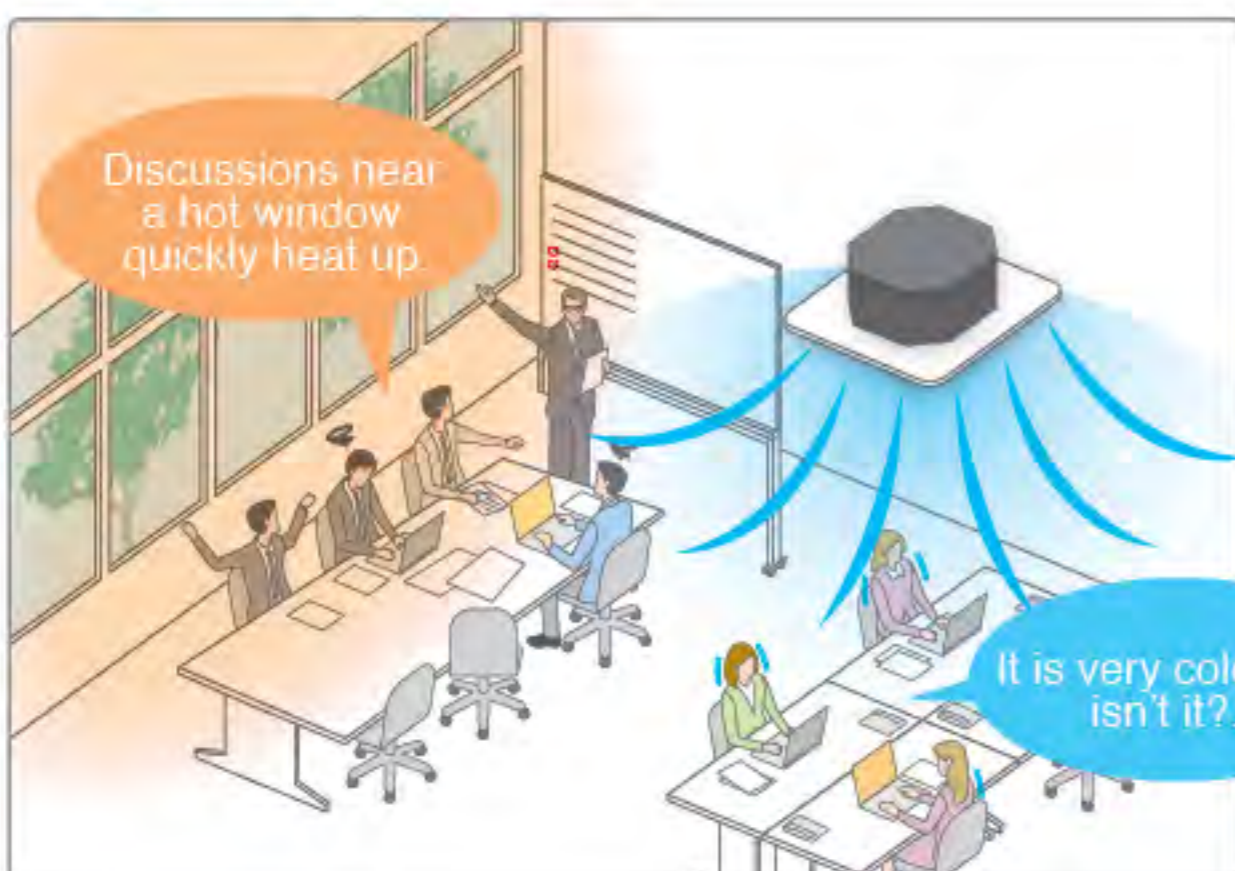

Daikin Sensing Technology ^{*2}

*2. Applicable when sensing panel (BYCQ125EEF/EEK) is installed.

Dual Sensors ^{*2}

◆ Dual sensors and individual airflow direction control automatically provide optimal control of airflow.

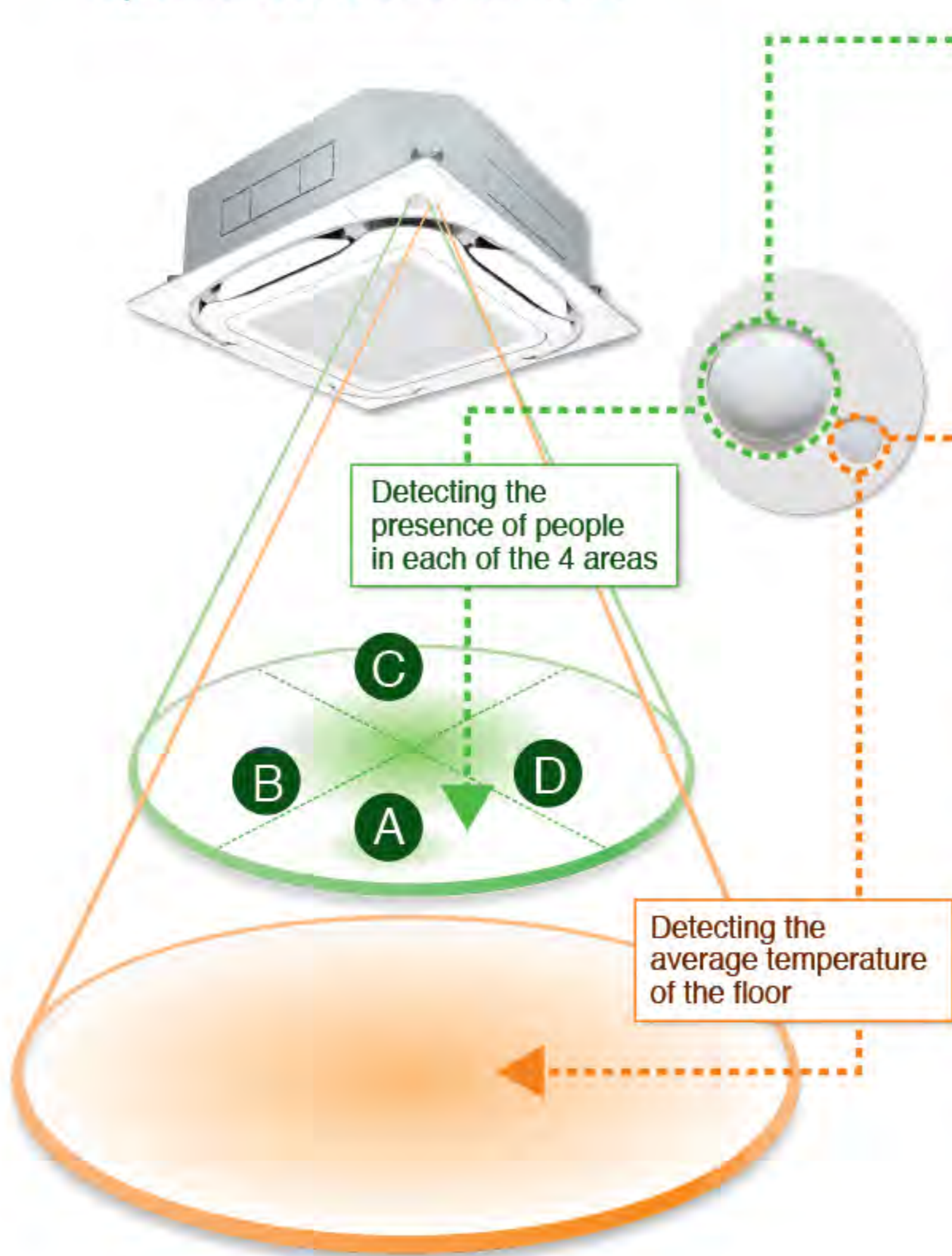

Infrared presence sensor

The sensor detects the presence of people in each of the 4 areas.

Ceiling height	2.7m	3.5m	4.0m
Detection range (diameter) ^{*3}	approx. 8.5m	approx. 11.5m	approx. 13.5m

*3. The infrared presence sensor detects 80cm above the floor.

Infrared floor sensor

The sensor detects the floor temperature and automatically adjusts operation of the indoor unit to reduce the temperature difference between the ceiling and the floor.

Ceiling height	2.7m	3.5m	4.0m
Detection range (diameter) ^{*4}	approx. 11m	approx. 14m	approx. 16m

*4. The infrared floor sensor detects at the floor surface.

Standard range for infrared presence sensor *

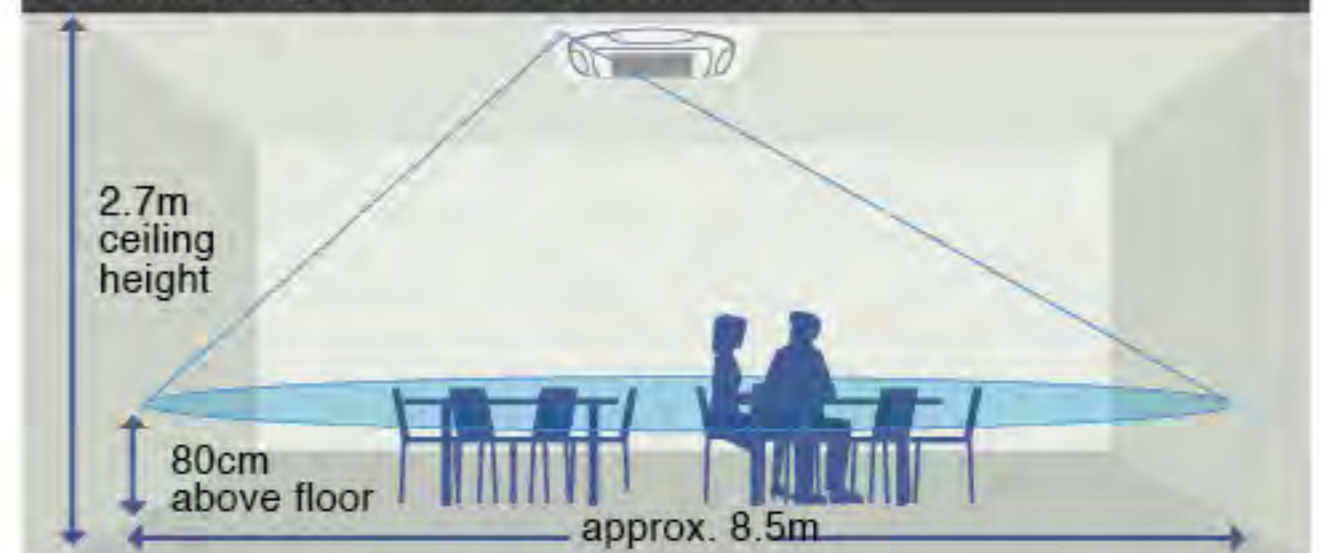

- [Concerning infrared presence sensor]
- People are detected by large movements such as the motion of people walking at a certain distance away from sensor.
 - Human detection is not possible for blind areas of sensor.
- [Concerning infrared floor sensor]
- The detected temperature may sometimes be affected by a heat source, window, or device emitting heat in the detection range.

Auto Airflow Functions ^{*5,6}

*5. Airflow direction should be set to "Auto".

*6. Applicable when BRC1E63 is used.

◆ Direct Airflow (default: OFF) **Cooling** **Dry**

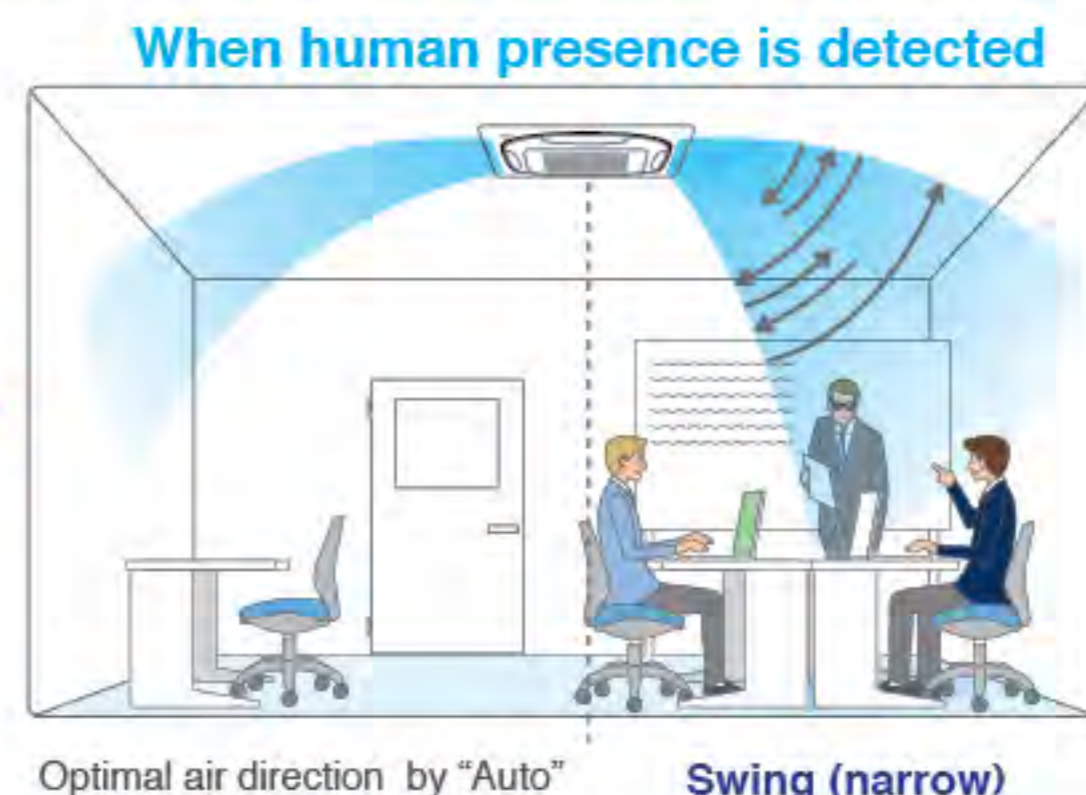
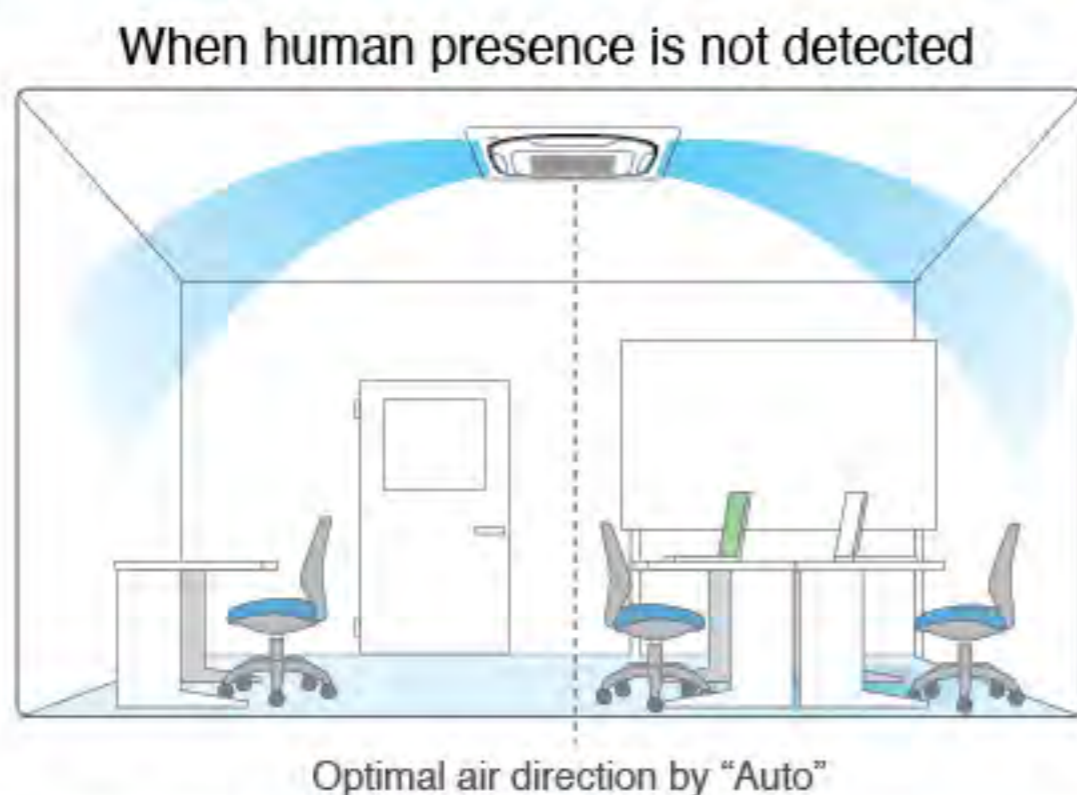

- With "Auto" airflow direction mode, flaps are controlled to deliver optimal airflow when the room is unoccupied.
- When human is not detected for 5 minutes, the unit automatically returns to controlling the flaps for an unoccupied room.
- When presence is detected, air direction is set to "Swing (narrow)" to deliver cool air to users.

Daikin Sensing Technology *1

*1. Applicable when sensing panel (BYCQ125EEF/EEK) is installed.

Comfort and Energy Saving Preventing Overcooling / Overheating*2

*2. Airflow direction and airflow rate should be set to "Auto".

◆ Floor temperature is detected and overcooling prevented. **Cooling**

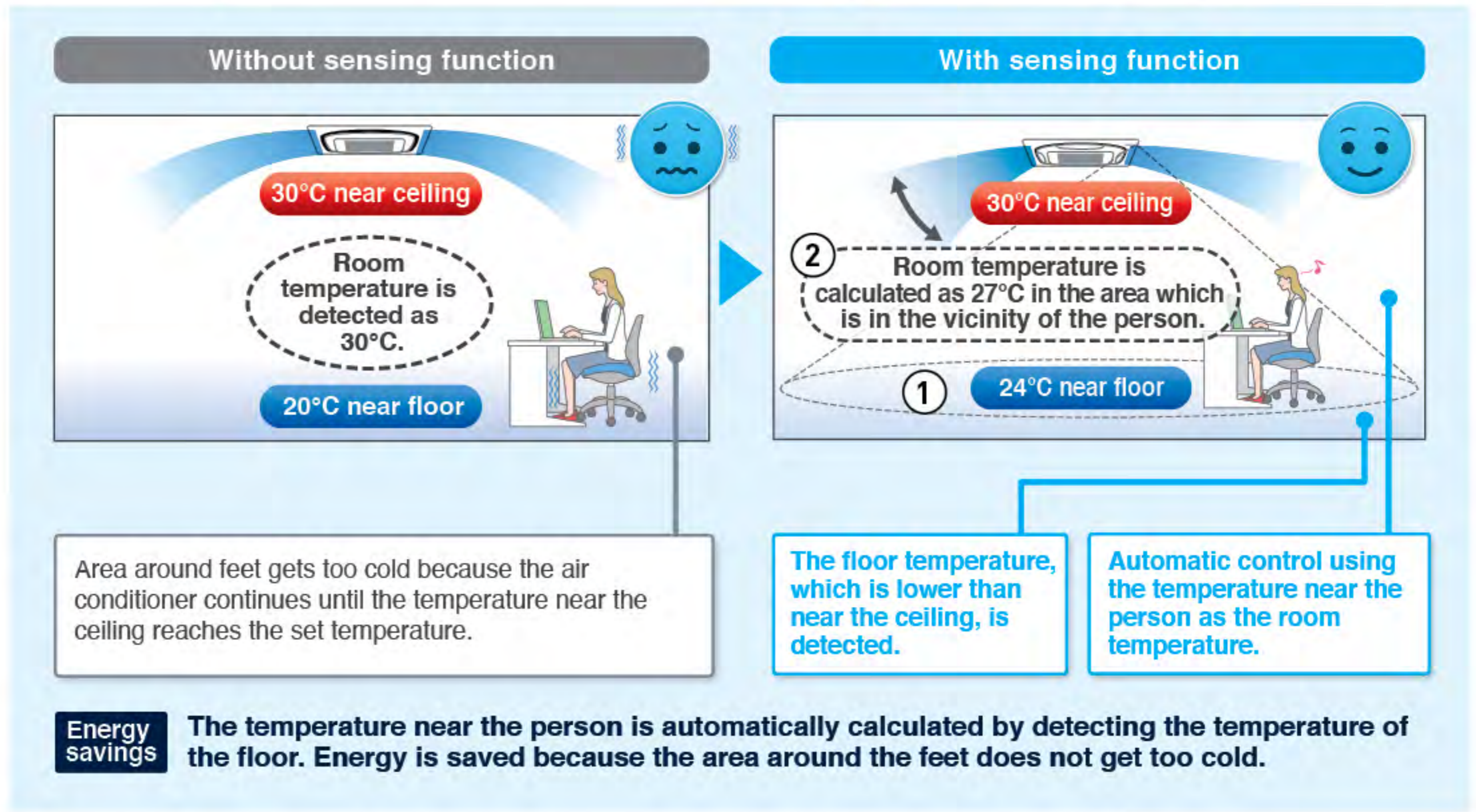

Sensing Sensor Functions*3,4,5

*3. Applicable when BRC1E63 or BRC1H61W(K) is used.

*4. These functions are not available when using the group control system.

*5. User can set these functions with remote controller.

◆ Sensing sensor low mode (default: OFF)

When there are no people in a room, the set temperature is shifted automatically.

- The system automatically saves energy by detecting whether or not the room is occupied. The set temperature is shifted automatically if the room is unoccupied.

Operation is reduced in places where there are no people.

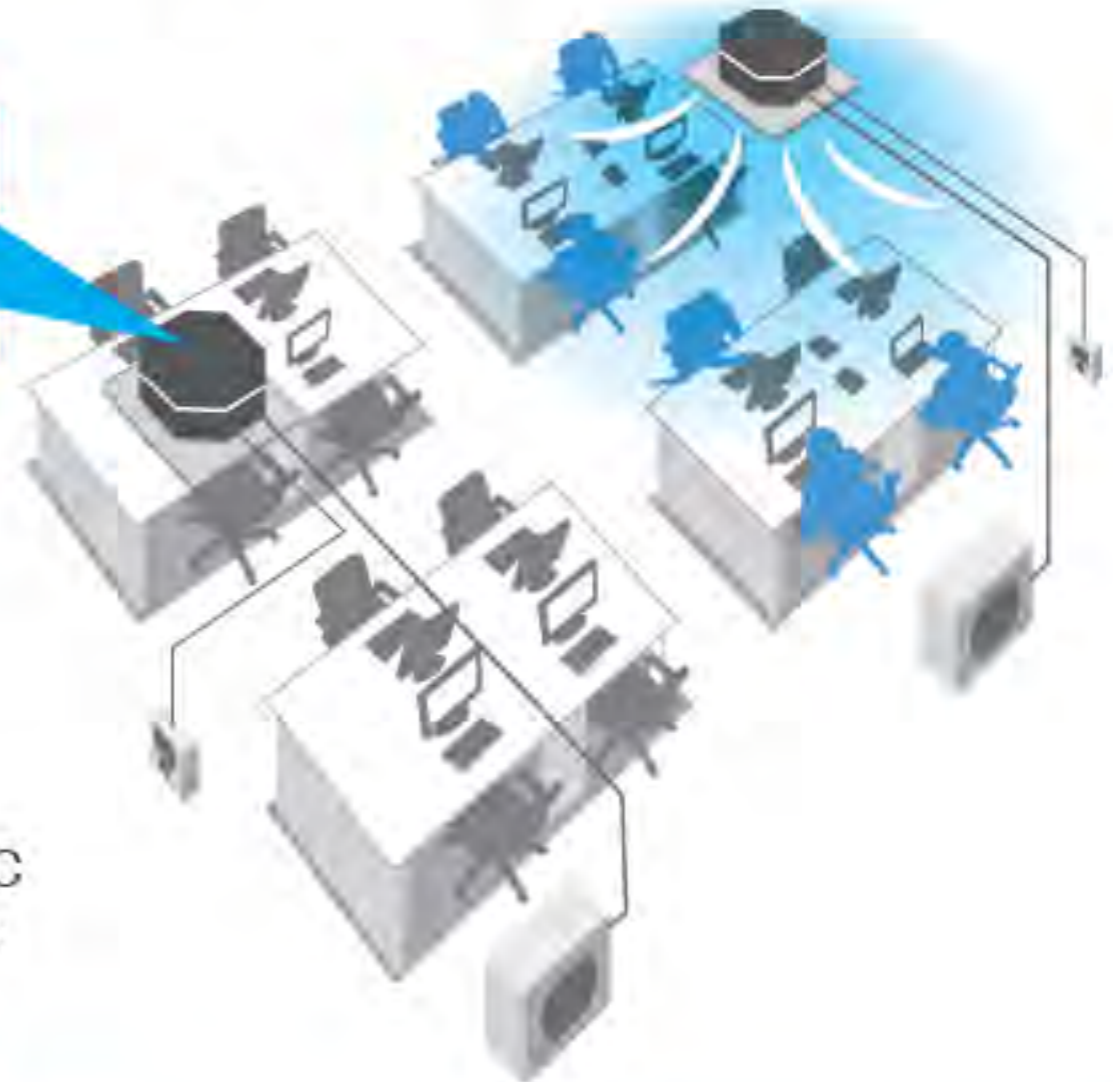

Example

- Cooling set temperature: 26°C
- Shift temperature: 1.0°C
- Shift time: 30 min.
- Limit cooling set temperature: 30°C

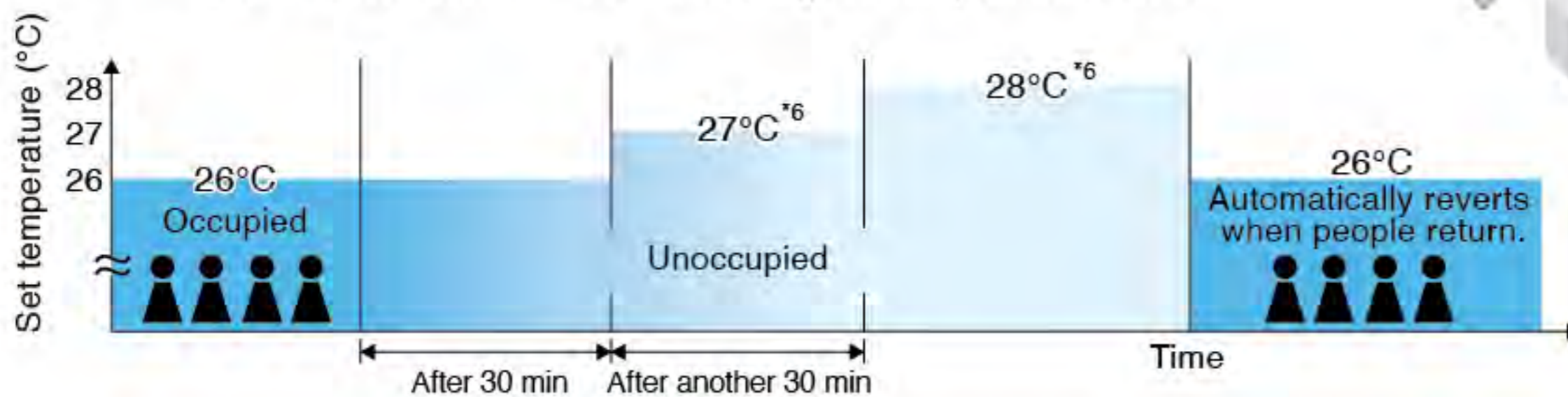

If people do not return, the air conditioner will raise the set temperature 1°C every 30 minutes and then operate at 30°C.

Shift temperature and time can be selected from 0.5 to 4°C in 0.5°C increments and 15, 30, 45, 60, 90 or 120 minutes respectively with remote controller.

*6. On basic screen of remote controller, set temperature does not change.

◆ Sensing sensor stop mode (default: OFF)

When there are no people in a room, the system stops automatically.*7,8

- The system automatically saves energy by detecting whether or not the room is occupied.
- Based on preset user conditions, the system automatically stops operation if the room is unoccupied.

Absent stop time can be selected from 1 to 24 hrs in 1 hr increments with remote controller.

*7. Please note that upon re-entering the room, the air conditioner will not switch on automatically.

*8. To protect the machine, the standby system may operate temporarily.



Comfort

◆ Unified square panels

Panel size is the same for all models. It is easy to maintain a neat appearance when multiple units are installed in the same room.



Same for all models

◆ Optimal comfort and convenience assured by 3 air discharge modes

Air direction	Standard setting ¹	Draft prevention setting (field setting)	Ceiling soiling prevention setting ² (field setting)
Desired situation	For gentle drafts.	When drafts are unwanted.	For shops with light coloured ceilings that must be kept spotless.
Auto-swing			
5-level air direction setting			
Draft prevention (In heating mode)		At heating startup and thermo OFF, air discharge is automatically set to a near horizontal to prevent direct exposure to cool air drafts.	
Auto air direction control		The air direction is set automatically to the memorised position of the previous air direction.	

Note:
¹Air direction is set to the standard position when the unit is shipped from the factory. The position can be changed from the remote controller.
²Closing of the corner discharge outlets is recommended.

◆ Switchable fan speed:

- FCF 5 steps and Auto
- FCFC 3 steps and Auto

◆ Suitable for high ceilings

Even in spaces with high ceilings, a comfortable airflow is carried down to the floor level.

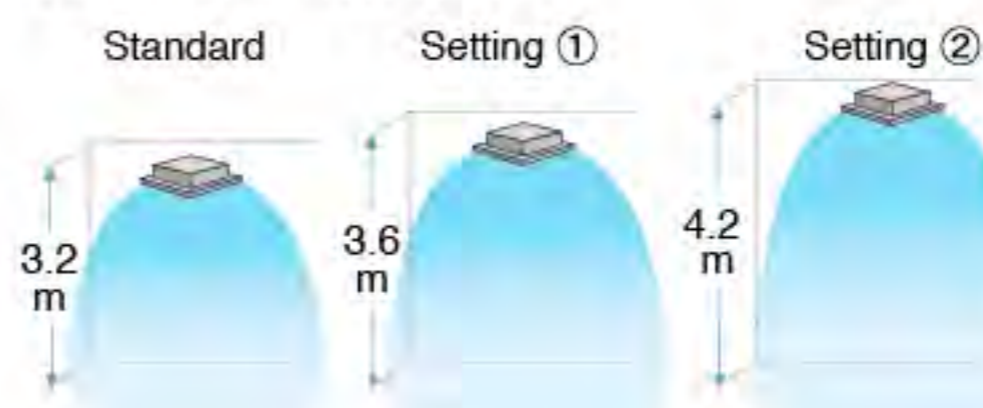

When all round flow is selected, ceilings up to 4.2 m in height can be accommodated. (FCF100/125C, FCFC100-140D)

◆ Quiet operation

Indoor unit	Sound pressure level dB(A)				
	H	HM	M	ML	L
FCF50-71C	37.0	34.5	32.0	29.5	27.5
FCF100C	45.0	41.5	38.0	35.0	32.5
FCF125C	46.0	43.0	40.0	36.0	32.5
FCFC100D	45.0	—	38.0	—	33.0
FCFC125/140D	46.0	—	40.0	—	33.0

■ Criteria for ceiling height and number of air discharge outlets (Ceiling height is reference value)

		Number of air discharge outlets used							
		FCF50-71C				FCF100/125C, FCFC100-140D			
		All round flow	4-way flow	3-way flow	2-way flow	All round flow	4-way flow	3-way flow	2-way flow
Ceiling height	Standard	2.7 m	3.1 m	3.0 m	3.5 m	3.2 m	3.4 m	3.6 m	4.2 m
	High ceiling ①	3.0 m	3.4 m	3.3 m	3.8 m	3.6 m	3.9 m	4.0 m	4.2 m
	High ceiling ②	3.5 m	4.0 m	3.5 m	—	4.2 m	4.5 m	4.2 m	—

Note:
 • The aforementioned is for standard panels. See the installation manual for designer panels.
 • Factory settings are for standard ceiling height and all-round flow.
 • High ceiling settings (1) and (2) are set with the remote controller by field setting.
 • High-efficiency filters are not available for high ceiling applications.

Cleanliness

◆ Silver ion anti-bacterial drain pan

A built-in antibacterial treatment that uses silver ion in the drain pan prevents the growth of slime, bacteria, and mould that cause odours and clogging. (The lifespan of a silver ion cartridge depends on the usage environment, but should be changed once every two to three years.)



◆ Non-flocking flaps

Flaps can be detached without use of tools. Condensation does not easily form and dirt does not cling to non-flocking flaps. They are easy to clean.



◆ Filter has anti-mould and antibacterial treatment

Prevents mould and microorganisms growing out of the dust and moisture that adheres to the filters.

Quick and Easy Installation

◆ Lightweight

All models can be installed without using a lifter.

◆ Installable in tight ceiling spaces

Standard panel

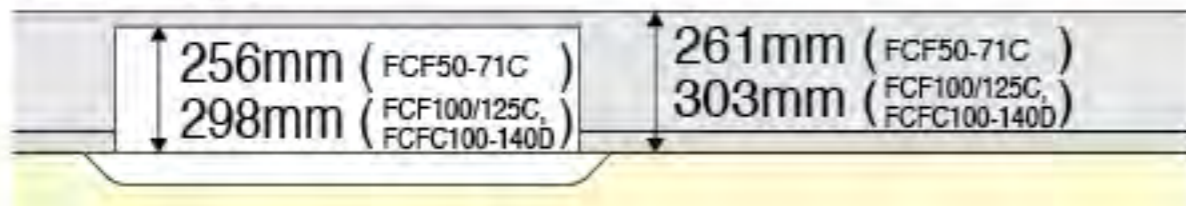

Designer panel

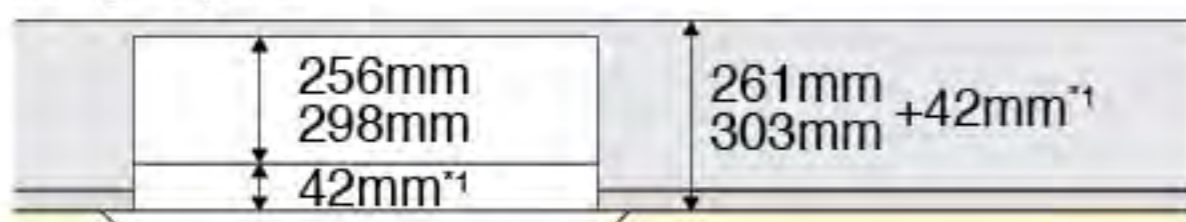

*1. Body height (ceiling required space) is 42 mm higher than standard panel.

Auto grille panel

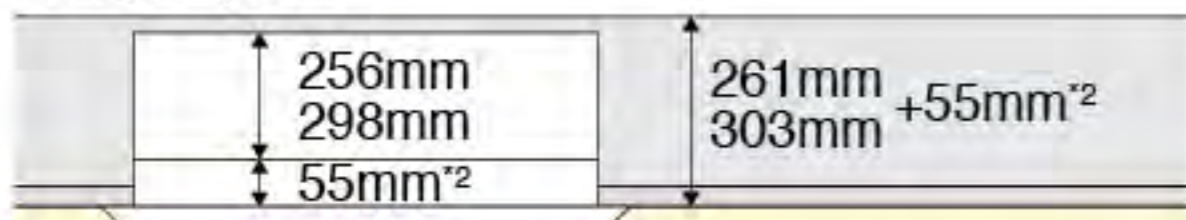

*2. Body height (ceiling required space) is 55 mm higher than standard panel.

*When the ceiling space is limited, an optional panel spacer is available. (see P.28)

◆ Temporary placement of control box lid

Because the control box lid can be temporarily hung on the unit, there is no need to climb down the stepladder to retrieve it.



The detached lid can be hung on a hook.

◆ Installed in any direction

Since the orientation of the suction grille can be adjusted after installing, the direction of the suction grille lines can be unified when multiple units are installed.

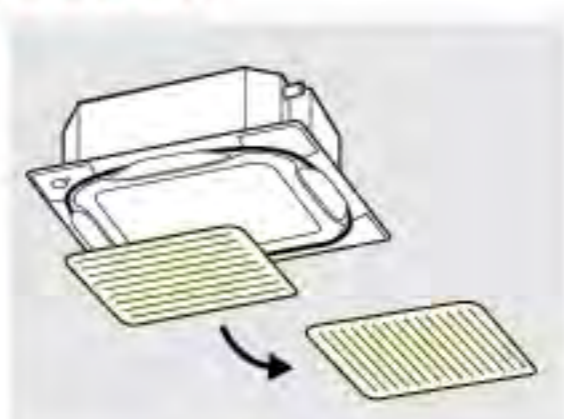

◆ Ease in temporary hanging of decoration panel

In addition to the temporary hanging fixtures in 2 places normally used, corner part mounting fixtures in 4 places are provided.

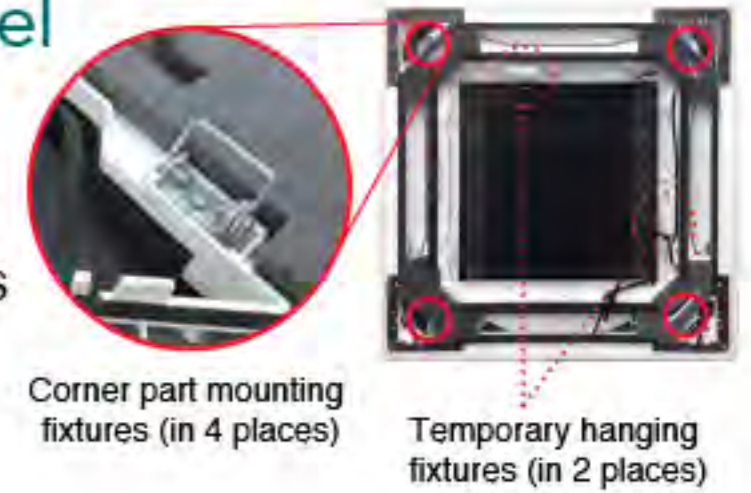

◆ Drain pump

Equipped as standard accessory with 850 mm lift.

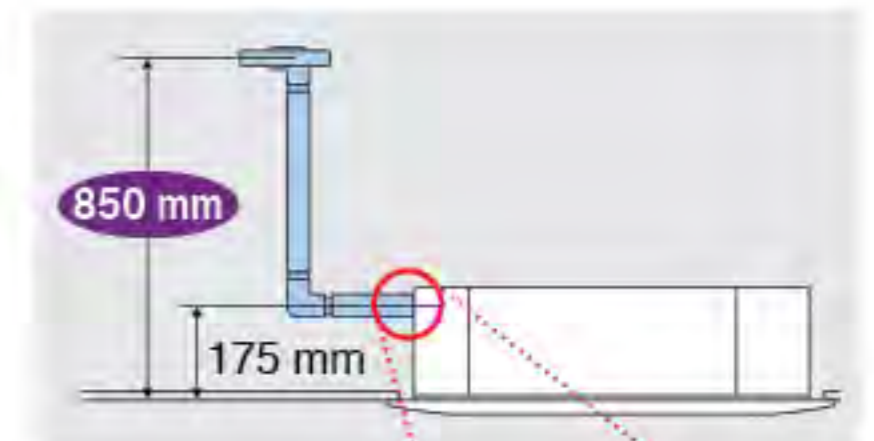

◆ Transparent drain socket



■ Hanging height adjustment

Because the configuration of the hanger bracket changed, the dimensions from the ceiling to the hanger bracket also change during height adjustment for indoor unit.

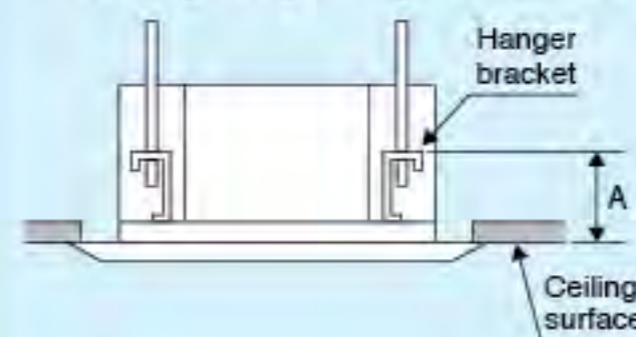

	A Dimensions
Standard panel	125-130mm
Designer panel	167-172mm
Auto grille panel	180-185mm
Chamber option*+ standard panel	175-180mm

*High-efficiency filter, ultra long-life filter, and fresh air intake

Easy Maintenance

◆ Condition of the drain pan and drain water

Can be checked by removing the suction grille and drain plug.

Note: For inquiries concerning auto grille panel installations, please contact your local dealer or Daikin representative.

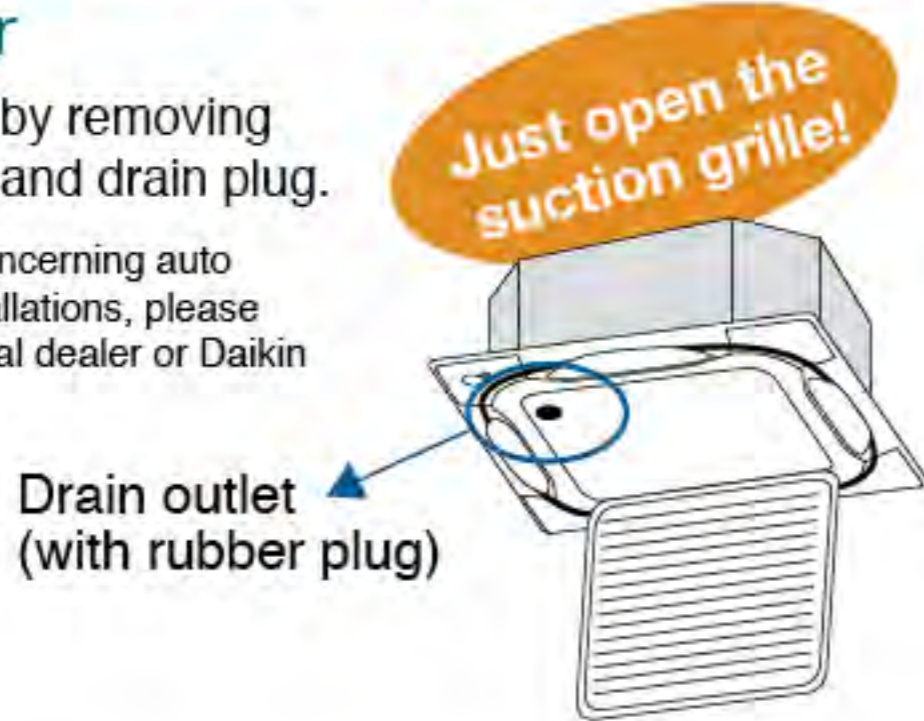

◆ 24 mm diameter drain outlet

The drain outlet allows insertion of a finger or dental mirror for inspection of the internal cleanliness of the drain pan. Removal of the suction panel enables access.



◆ Auto grille panel (option)

Grille and air filter cleaning can be performed without need for a stepladder by lowering the grille.

A dedicated remote controller for the auto grille panel is included. Operation is not possible using other remote controllers.

The drop length corresponds to ceiling height and can be set for 8 different levels.

Ceiling Height Standard (m)	Drop Length
2.4	1.2
2.7	1.6
3.0	2.0
3.5	2.4
3.8	2.8
4.2	3.1
4.5	3.5
5.0*	3.9

*Airflow range is up to 4.5m. Please refer to "criteria for ceiling height and number of air discharge outlets" on Page 25 (installation conditions)



Options

Options required for specific operating environments

◆ Ultra long-life filter unit

Even in dusty environments where the air conditioning is constantly operating, the ultra long-life filter only has to be cleaned once a year.



Dusty area: annual filter change

*For dust concentration of 0.3 mg/m³ (Requires separately sold Air purifier.)
1 year (Approx. 5,000 hr) ≈ 15 hr/day x 28 day/month x 12 month/year

Ordinary store or office: filter change every 4 years

*For dust concentration of 0.15 mg/m³
4 years (Approx. 10,000 hr) ≈ 8 hr/day x 25 day/month x 12 month/year x 4 years

◆ High-efficiency filter unit

Available in two types: 65% and 90% colorimetry.

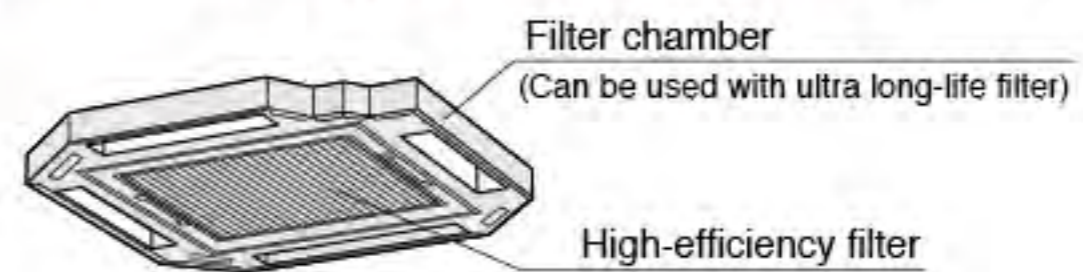

Insulation kit for high humidity

Please use if you think the temperature and humidity inside the ceiling exceeds 30°C and RH 80%, respectively.

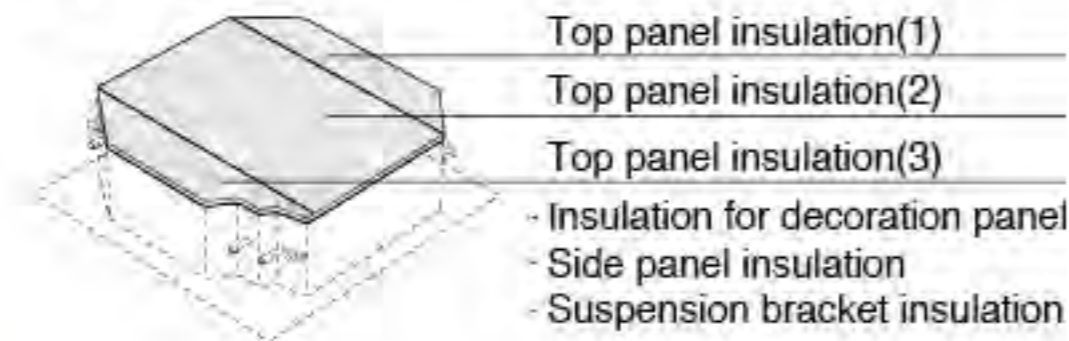

Panel spacer

Use when only minimal space is available between drop ceilings and ceiling slabs.

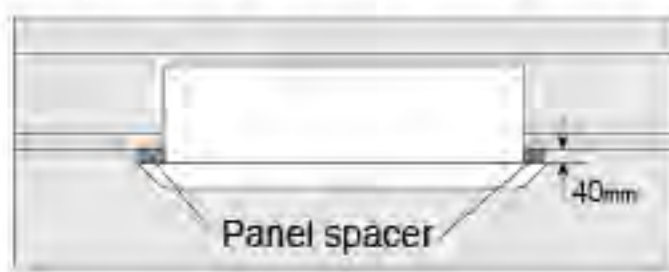

Note: Some ceiling constructions may hinder installation. Contact your Daikin Dealer before installing your unit.

Sealing material of air discharge outlet

By using this option, 2-way, 3-way, or 4-way flow can be selected.

Branch duct chamber

This chamber lets you connect a round flexible duct to the air discharge opening at any time after the original installation.

Fresh air intake kit Note 1.2

Using this kit, a duct can be connected to take in outdoor air. There are two chamber types that have intake in two places: with T-duct joint and without T-duct joint.

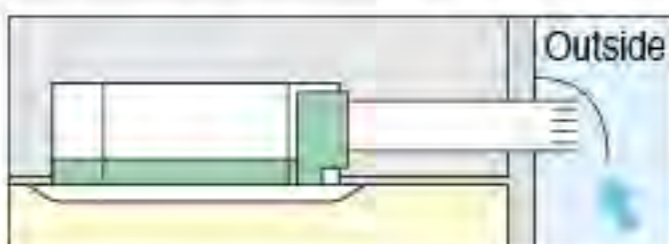

The units can be installed in the following different ways

Chamber type (without T-duct joint) Note 3.4.5

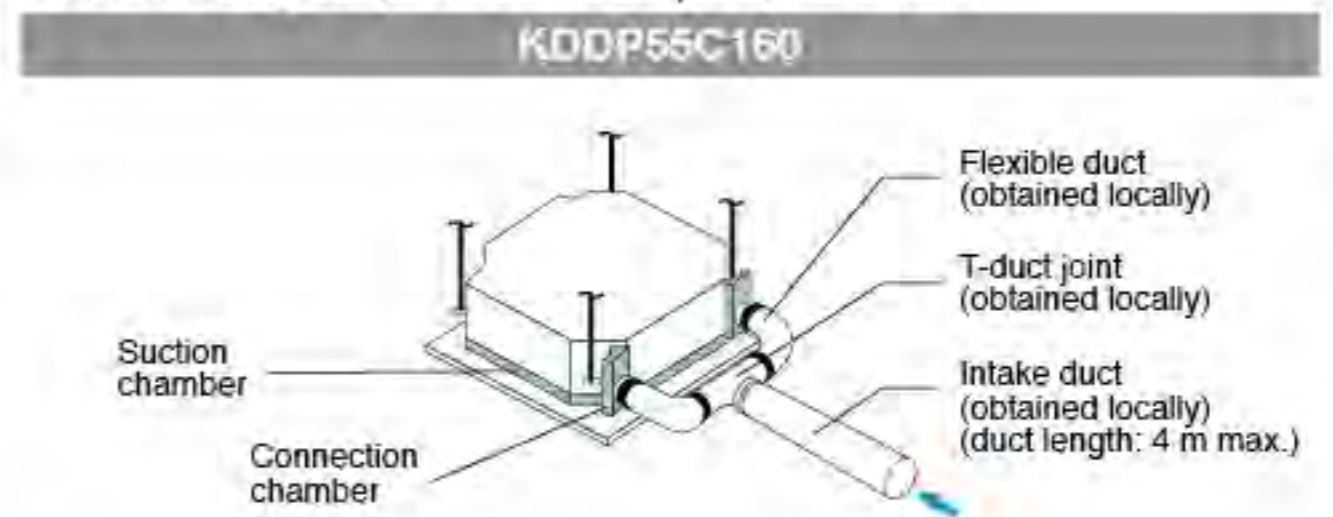

Chamber type (with T-duct joint) Note 3.4.5

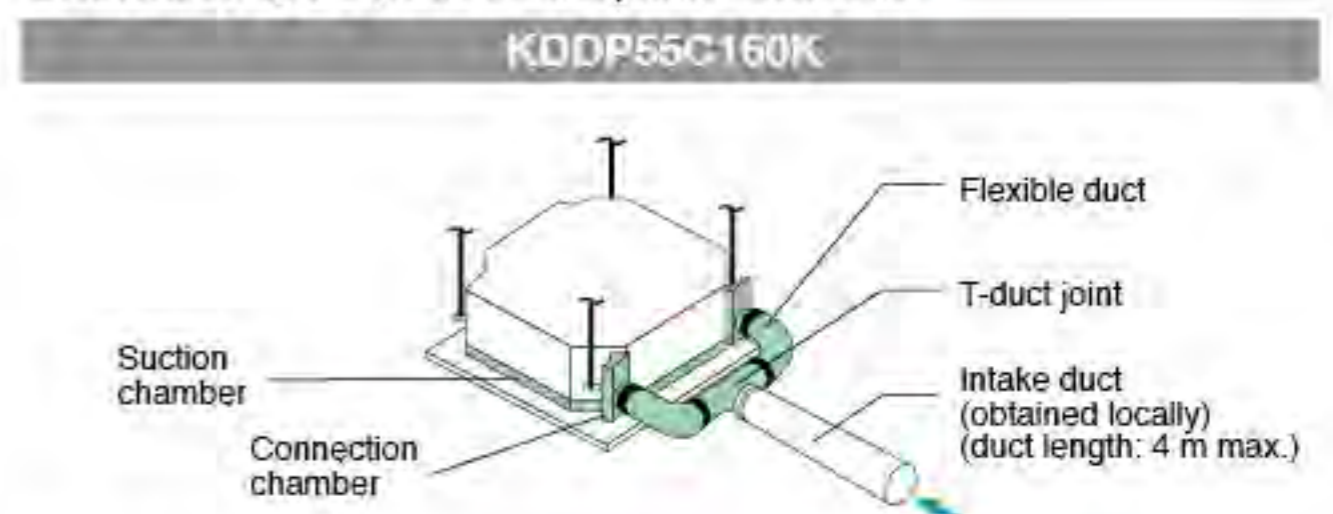

Direct installation type Note 6

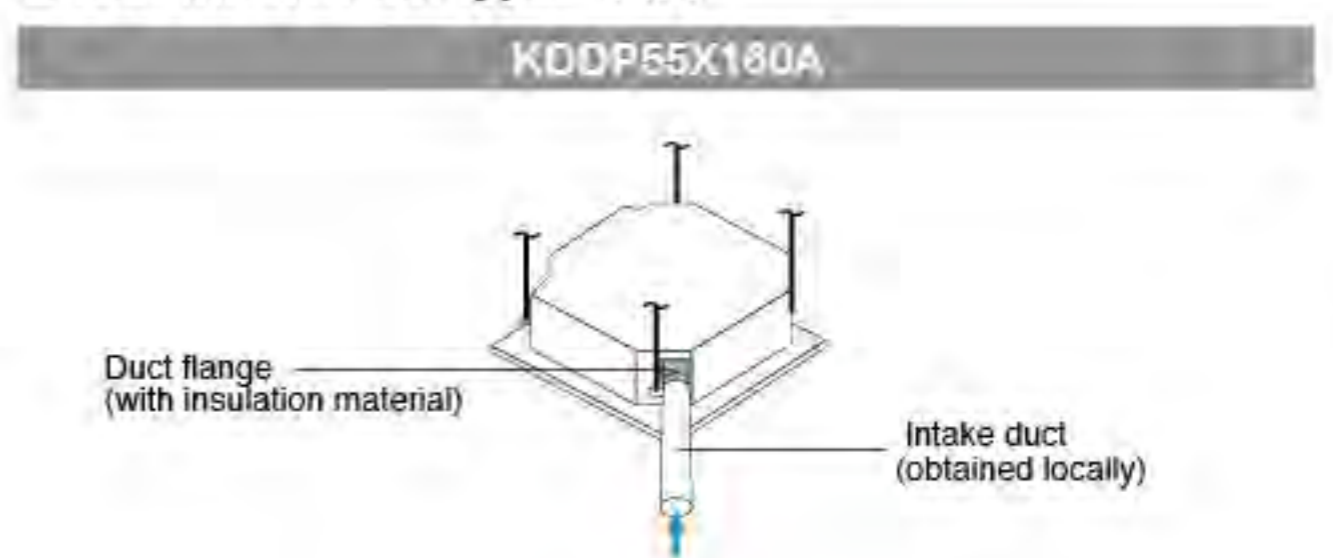

- Note:
1. Use of options will increase operating sound.
 2. Connecting ducts, fan, insect nets, fire dampers, air filters, and other parts should, as required, be obtained locally.
 3. When a local-obtained fan is used, an interlock with air conditioner is necessary. Optional PCB (BRP11B62) is required for interlocking.
 4. When installing a fresh air intake kit (chamber type), two air outlet corners are closed.
 5. It is recommended that the volume of outdoor air introduced through the kit is limited to 10% of the maximum airflow rate of the indoor unit. Introducing higher quantities will increase the operating sound and may also influence temperature sensing.
 6. The volume of fresh air for direct installation type is approximately 1% of the indoor unit airflow.
The chamber type is recommended when more fresh air is necessary.

Fully flat cassette, a remarkable blend of iconic design and engineering excellence



NEW
FFFC35/50AVMG



Accessory required for indoor unit.

Wired Remote Controller

- Stylish Remote Controller (Wired) *1
(Option)



BRC1H61W
(White)



BRC1H61K
(Black)

- Navigation Remote Controller (Wired) *1
(Standard)



BRC1E63

- Simplified Remote Controller (Wired) *1
(Option)



BRC2E61

Wireless Remote Controller

- Wireless Remote Controller *2
(Standard)



Cooling only
BRC7M531W

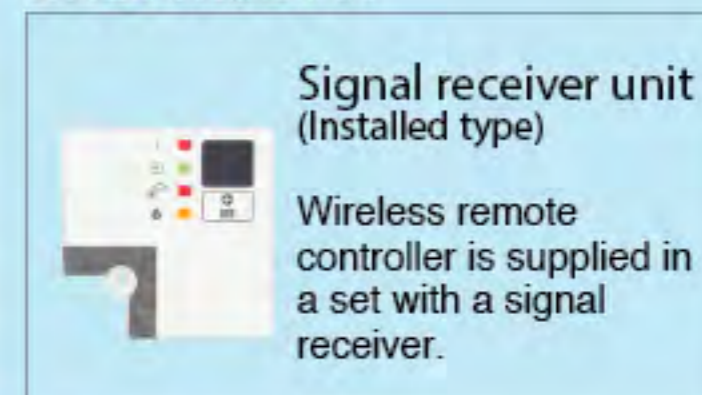

Signal receiver unit
(Installed type)

Wireless remote controller is supplied in a set with a signal receiver.

Note: *1 Remote controller cable is not included and must be obtained locally.

Note: *2 A signal receiver must be added to the indoor unit.

Fully Flat with the Ceiling

- Fully-flat integration in standard architectural ceiling tiles, leaving only 8 mm.

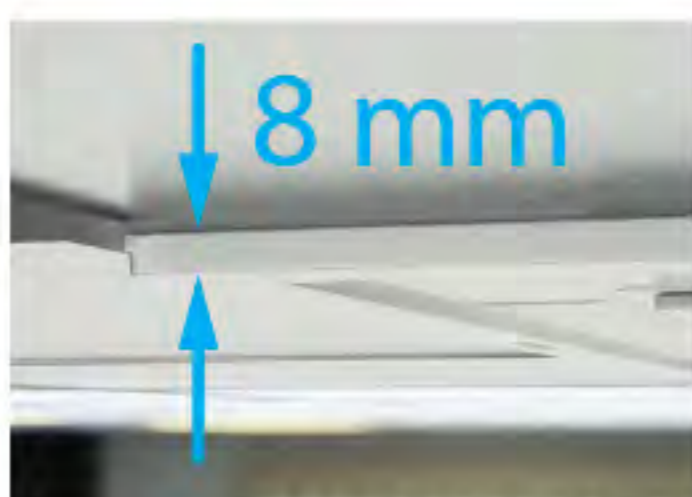

Fits Architectural Ceiling Tiles Perfectly

- The newly designed panel integrates fully within one ceiling tile enabling lights, speakers and sprinklers to be installed in the adjoining ceiling tiles.

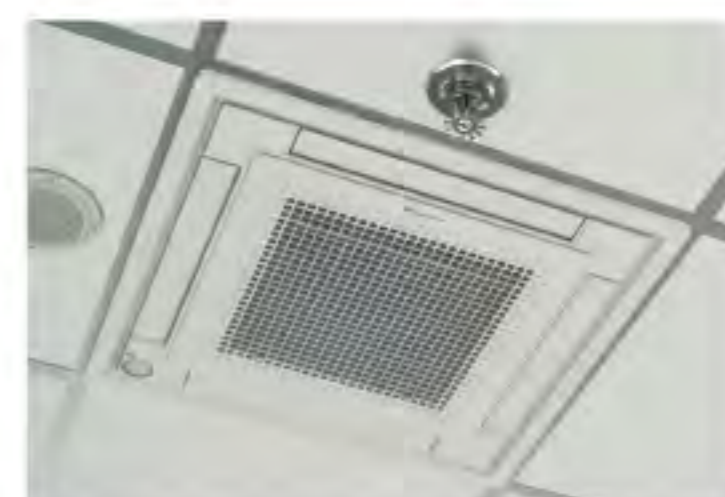

Unobtrusive cassette

Specification	Option
P.57	P.61

Compact

- Sized to fit inside 600mm wide ceiling grids

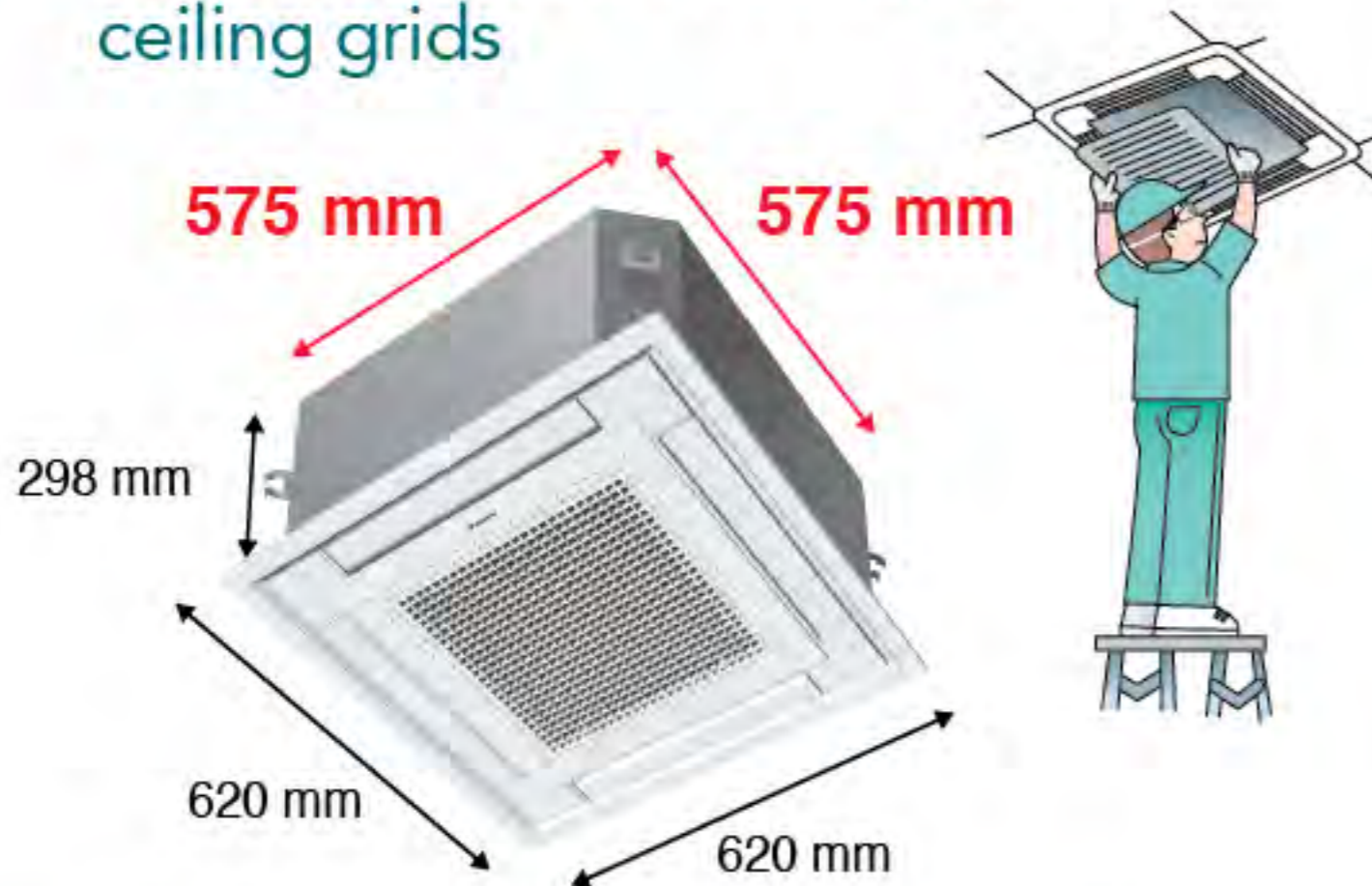

- Inspection opening is necessary on the control box and drain pump side.

Sensing technology ^{*1}

*1. Applicable when optional sensor kit (BRYQ60AAW) is used.

- Dual sensors (Option)

- An optional presence and floor sensor kit can be fitted to the cassette for draft prevention, energy-saving operation, and to provide optimal control of airflow.



- Direct air, Draft prevention (default: OFF)^{*2}

*2. Applicable when BRC1E63 is used.

- When human presence is detected, air direction is set to "Swing (narrow)" to deliver cool air to users, or drafts are prevented by making the flap horizontal.



Optimal air direction by "Auto" Swing (narrow)

- Sensing sensor low / stop mode (default: OFF)^{*3}

*3. Applicable when BRC1E63 or BRC1H61W(K) is used.

- When there are no people in a room, the set temperature is shifted or the system stops automatically for energy saving.

Individual airflow direction control ^{*3}

*3. Applicable when BRC1E63 or BRC1H61W(K) is used.

- Airflow direction can be individually adjusted for each air discharge outlet to deliver optimal air distribution.

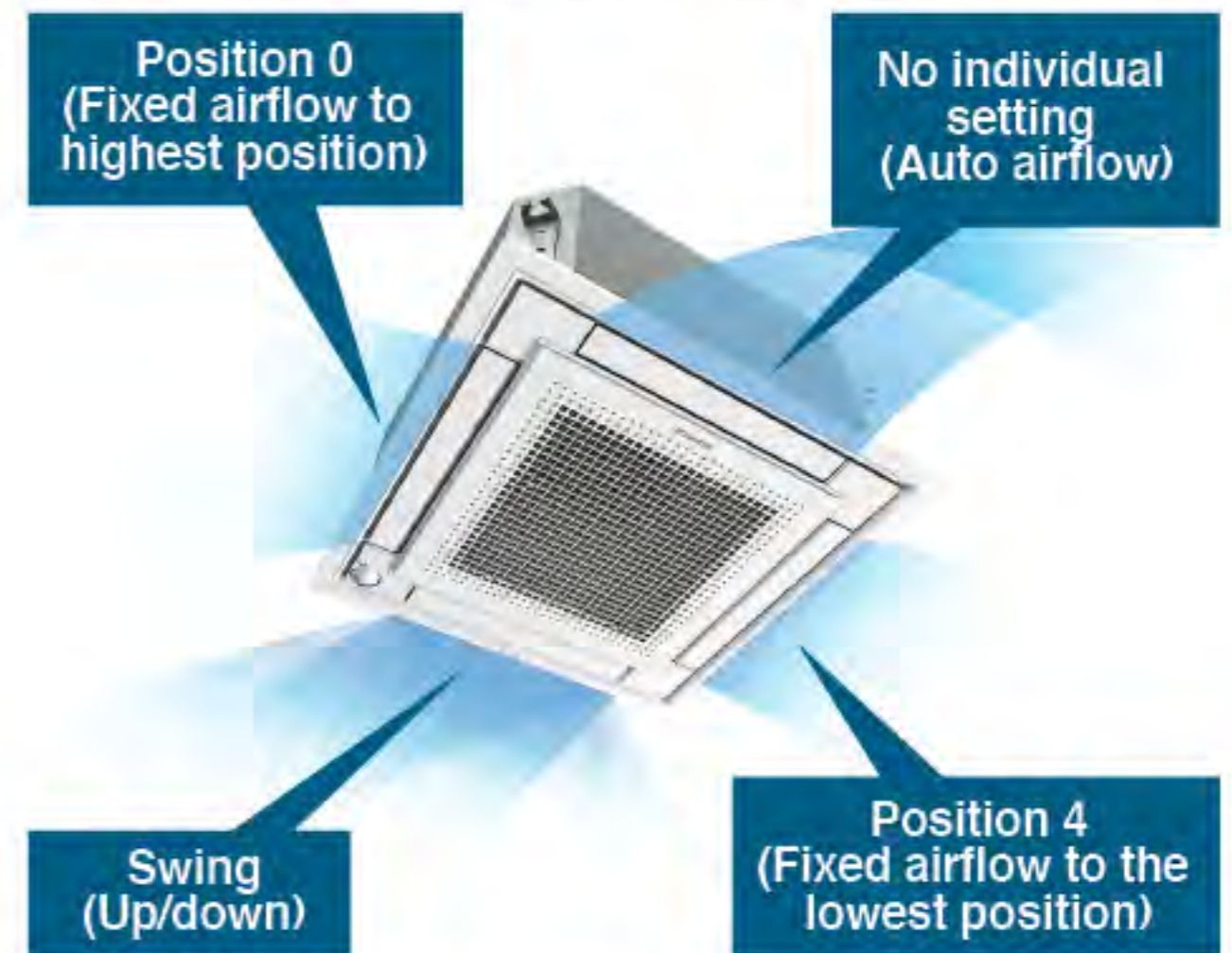

Comfort

- Fan speed: 3 steps and Auto

- Suitable for high ceilings

Even in spaces with high ceilings, a comfortable airflow is carried down to the floor level.

*Field setting with remote controller.

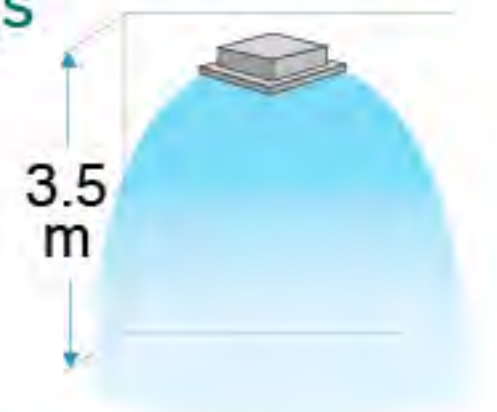

- Optimal comfort and convenience

	Auto-swing	5-levels air direction setting
Standard setting		
Draft prevention setting (Field setting)		
Setting to prevent soiling of ceiling (Field setting)		

- Selectable airflow pattern

4-way flow	3-way flow	2-way flow

■ Drain socket □ Piping ■ Sealing material (Option)

*For 3-way or 2-way flow, the sealing material of air discharge outlet (option) must be used.

*Field setting with remote controller.

Middle static type allows greater flexibility



FBFC50/60/71/100/125/140DVM

Accessory required for indoor unit.

Wired Remote Controller

- Stylish Remote Controller (Wired) *1

(Option)



BRC1H61W (White)



BRC1H61K (Black)

- Navigation Remote Controller (Wired) *1

(Standard)



BRC1E63

- Simplified Remote Controller (Wired) *1

(Option)



BRC2E61

Wireless Remote Controller

- Wireless Remote Controller *2

(Standard)

Cooling only
BRC4C66



Signal receiver unit (Installed type)

Wireless remote controller is supplied in a set with a signal receiver.

Note: *2A signal receiver must be added to the indoor unit.

Simultaneous air conditioning of two rooms and ventilation grille (ventilation opening)

When air conditioning two rooms simultaneously, the air discharged into each room must be circulated back to the air conditioner. To achieve this, a ventilation duct should be installed for each room or one of the indicated ventilation grilles should be installed on the partitioning wall or under the door between the rooms.

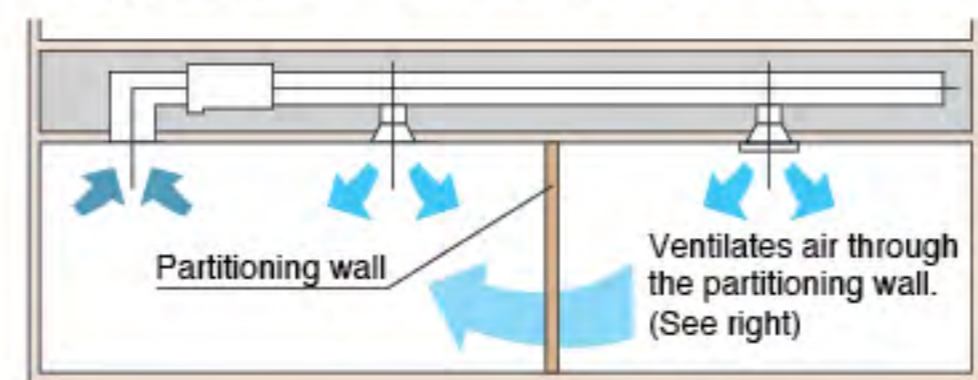

Note: The under-door cutout method should be used only when there is a small volume of airflow.

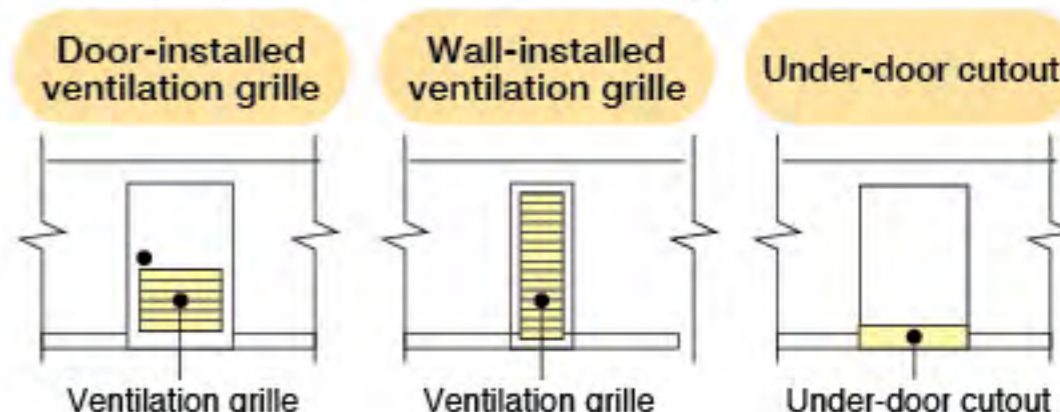

Specification	Option
P.58	P.61

Design and Installation Flexibility

◆ Only 245 mm high

Installation is possible even in buildings with narrow ceiling spaces.

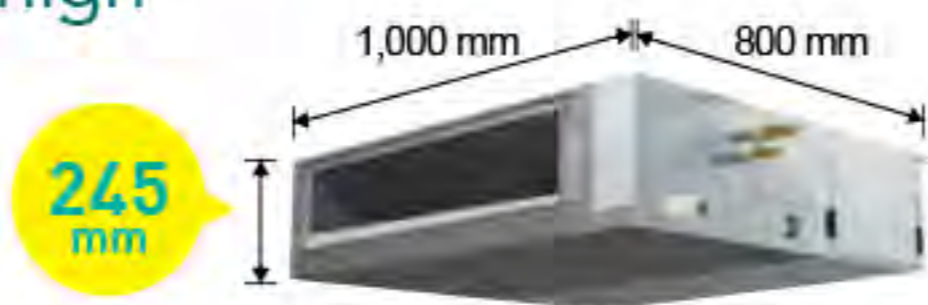

One of the industry's most compact bodies in the mid-static pressure range.

Indoor unit	FBFC50/60D	FBFC71D	FBFC100/125/140D
Height	245 mm		
Width	700 mm	1,000 mm	1,400 mm
Depth	800 mm		

◆ Bottom suction is available

Wiring and servicing can be done from the underside of the unit (an option part required).

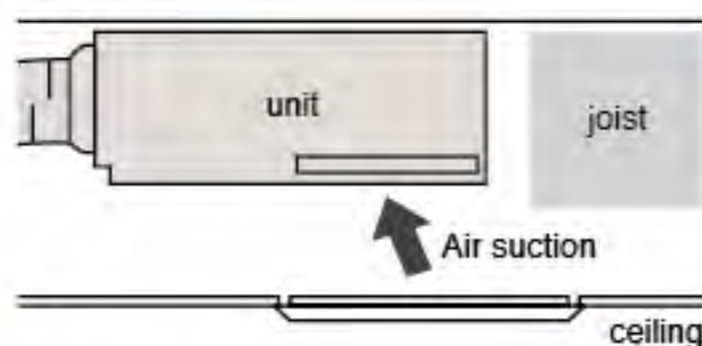

Rear suction

Bottom suction

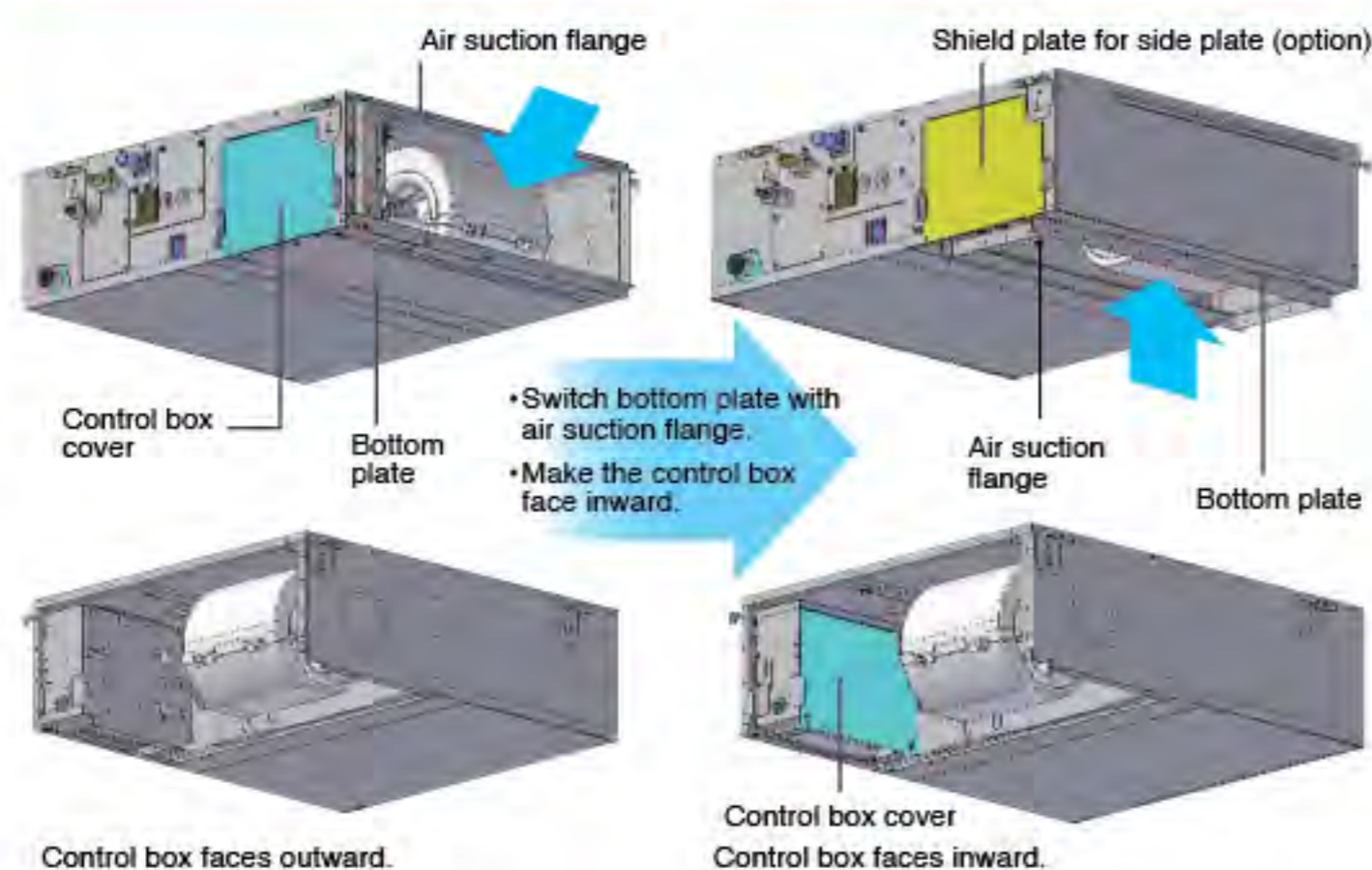

◆ Higher lift is realized (Option)

A DC drain pump with optional accessory is utilised.



Comfort

◆ Switchable fan speed: 3 steps and Auto

"Auto" is applicable when wired remote controller is used.

High Efficiency

◆ DC fan motor and DC drain pump (Option)

These are utilised to improve energy efficiency.

◆ Adjustable E.S.P.

External static pressure can be controlled to within a range of 50 Pa to 150 Pa (FBFC100-140)* by using a DC fan motor.



Set to low static pressure when ducts are short.

Set to high static pressure for advanced needs such as when using dampers and long ducts.

Comfort airflow is achieved in accordance with conditions such as duct length.

*30-130 Pa for FBFC50/60, 40-140 Pa for FBFC71.

◆ Airflow rate auto adjustment function

Controls the airflow rate using a remote controller during test run.

It is automatically adjusted to approximately $\pm 10\%$ of the rated H tap airflow.

◆ Interlock control

As an energy saving feature, the room air conditioning unit can be interlocked with the hotel key card system. Using a 3rd-party building management system, air conditioning and lighting can be interlocked.

* Field setting with remote controller



◆ DIII-NET communication standard

Connection to a centralised control system is available without need for an optional adaptor.

Easy Maintenance

◆ Position of drain pan inspection opening

Modified for easier inspection work.

◆ Drain pan maintenance check window

This makes it possible to inspect for drain pan dirt and to confirm drainage during installation without the use of tools.



Clean

◆ Silver ion anti-bacterial drain pan

A built-in antibacterial treatment that uses silver ion in the drain pan prevents the growth of slime, bacteria, and mould that cause odours and clogging. (The lifespan of a silver ion cartridge depends on the usage environment, but should be changed once every two to three years.)



Comfortable airflow travels throughout the room



FHFC50/60/71DV1G



FHFC100/125/140DV1G

Accessory required for indoor unit.

Wired Remote Controller

- Stylish Remote Controller (Wired) ^{*1}
(Option)
- Navigation Remote Controller (Wired) ^{*1}
(Standard)
- Simplified Remote Controller (Wired) ^{*1}
(Option)



BRC1H61W
(White)



BRC1H61K
(Black)

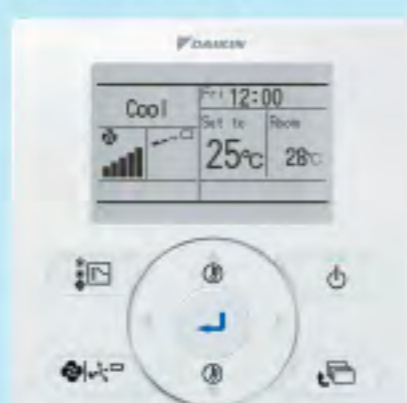

BRC1E63



BRC2E61

Wireless Remote Controller

- Wireless Remote Controller ^{*2}
(Standard)
- FHFC50-71D Cooling only
BRC7EA66
- FHFC100-140D Cooling only
BRC7GA56

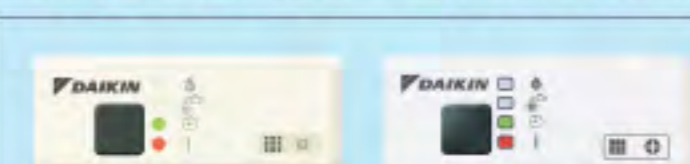

Signal receiver unit (Installed type)
Wireless remote controller is supplied in a set with a signal receiver.

Note: ^{*2}A signal receiver must be added to the indoor unit.

Note: ^{*1}Remote controller cable is not included and must be obtained locally.

Specification	Option
P.59	P.63

Stylish Model

- ◆ **Sophisticated design**
Flap neatly closes when not in use. (100-140 class)
- ◆ **White colour**



Comfort

- ◆ The technology of the DC fan motor (100-140 class), wide sirocco fan, and large heat exchanger combine for greater airflow and quiet operation
- ◆ Auto swing (up and down) and louvers (left and right by hand) bring comfort to the room
- ◆ Louver manually adjusts for straight or wide angle airflow

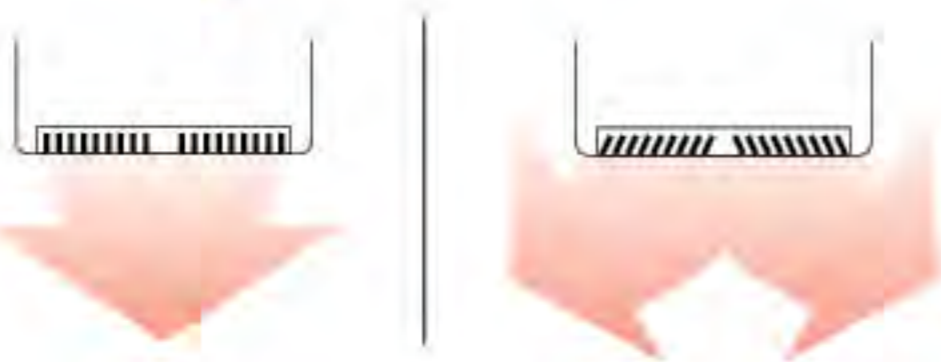

- ◆ **Suitable for high ceilings**

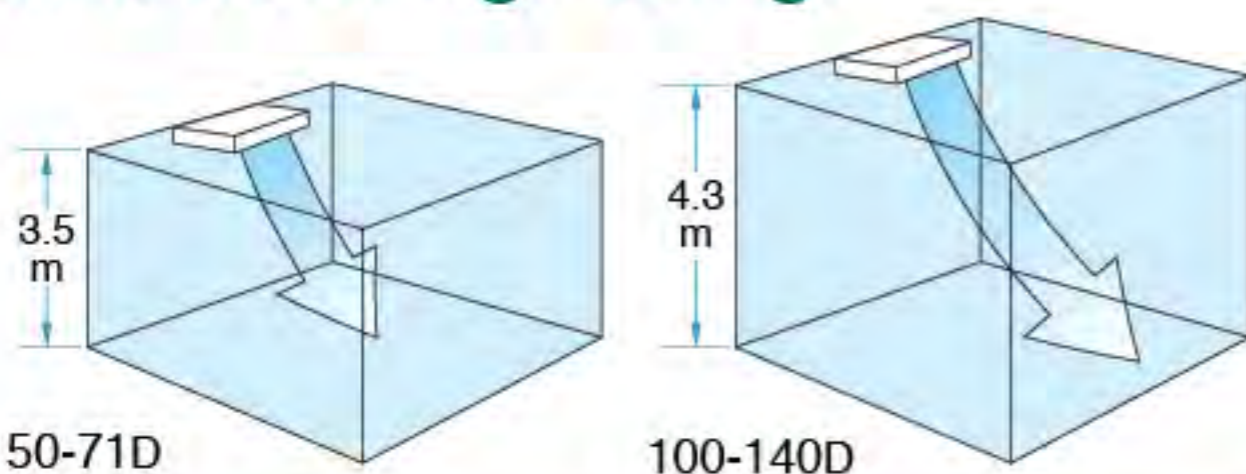

50-71D

100-140D

	50-71D	100D	125/140D
Standard	2.7m or less	3.8m or less	4.3m or less
High ceiling	2.7m-3.5m	3.8m-4.3m	—

Note: Factory settings is "standard".
"High ceiling" are set with remote controller by field setting.

- ◆ **Switchable fan speed:**
2 steps (50-71 class)
3 steps and Auto (100-140 class)
Auto airflow rate is available when wired remote controller is used.

Installation Flexibility for Freedom of Design

- ◆ **Flexible installation**

The unit fits more snugly into tight spaces.



*Water used in the test-run can be drained from the air discharge opening rather than from the side as was formerly the case.

- ◆ **Drain pump kit (option) can be easily incorporated**

Drain pipe connection can be done inside the unit. Refrigerant and drain pipe outlets are at the same opening.

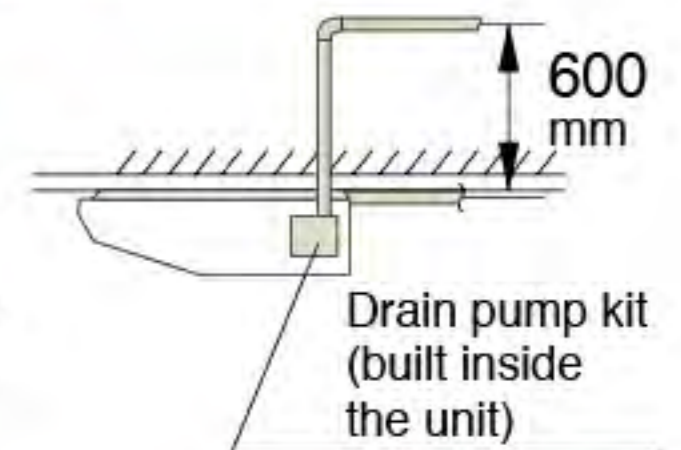

- ◆ **DIII-NET communication standard (100-140 class)**

50-71 class requires an optional adaptor.

- ◆ **All wiring and internal servicing can be done from under the unit**

- ◆ **The rear side removable frame allows ease of access for piping work (100-140 class)**

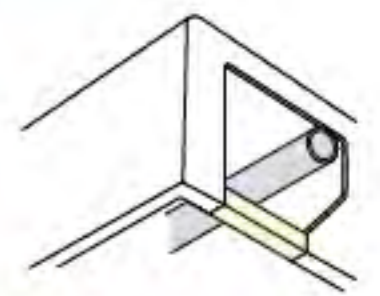

Easy Maintenance

- ◆ **Drain pump kit (option) includes a silver ion antibacterial agent**
That assists in preventing the growth of slime, bacteria, and mould that cause odours and clogging.

- ◆ **Non-flocking flap**

Condensation does not easily form and dirt does not cling to non-flocking flap. It is easy to clean.

Non-flocking flap



- ◆ **Easy-clean, flat surfaces**

It is easy to wipe dirt off the flat side and lower surfaces of the unit.

Oil Resistant Grille

- ◆ **Oil-resistant plastic is used for the air suction grille.**

This satisfies durability in restaurants and other similar environments.

Note:
Intended for use in salons, dining rooms, and ordinary sales floors, this specification is not suitable for kitchens or other harsh environments.

Compact design and easy installation



FAFC100AV1G

Accessory required for indoor unit.

Wired Remote Controller

- Navigation Remote Controller (Wired) ¹

(Standard)



BRC073A5

Note: ¹Remote controller cable is not included and must be obtained locally.

Accessory

Wireless Remote Controller

- Wireless Remote Controller ²

(Standard)



Cooling only
ARC466A14

Note: ²A signal receiver is included to the indoor unit.

Specification	Option
P.57	P.63

Compact & Sophisticated Design

- ◆ Flaps neatly close
When not in use.
- ◆ Pure white colour



Comfort

- ◆ Auto swing (up/down, left/right)

The flaps (horizontal blades) for up and down auto swing and louvres (vertical blades) for left and right auto swing are available. By pushing both buttons, the flaps and louvres swing in turn, circulating air to every part of a room.

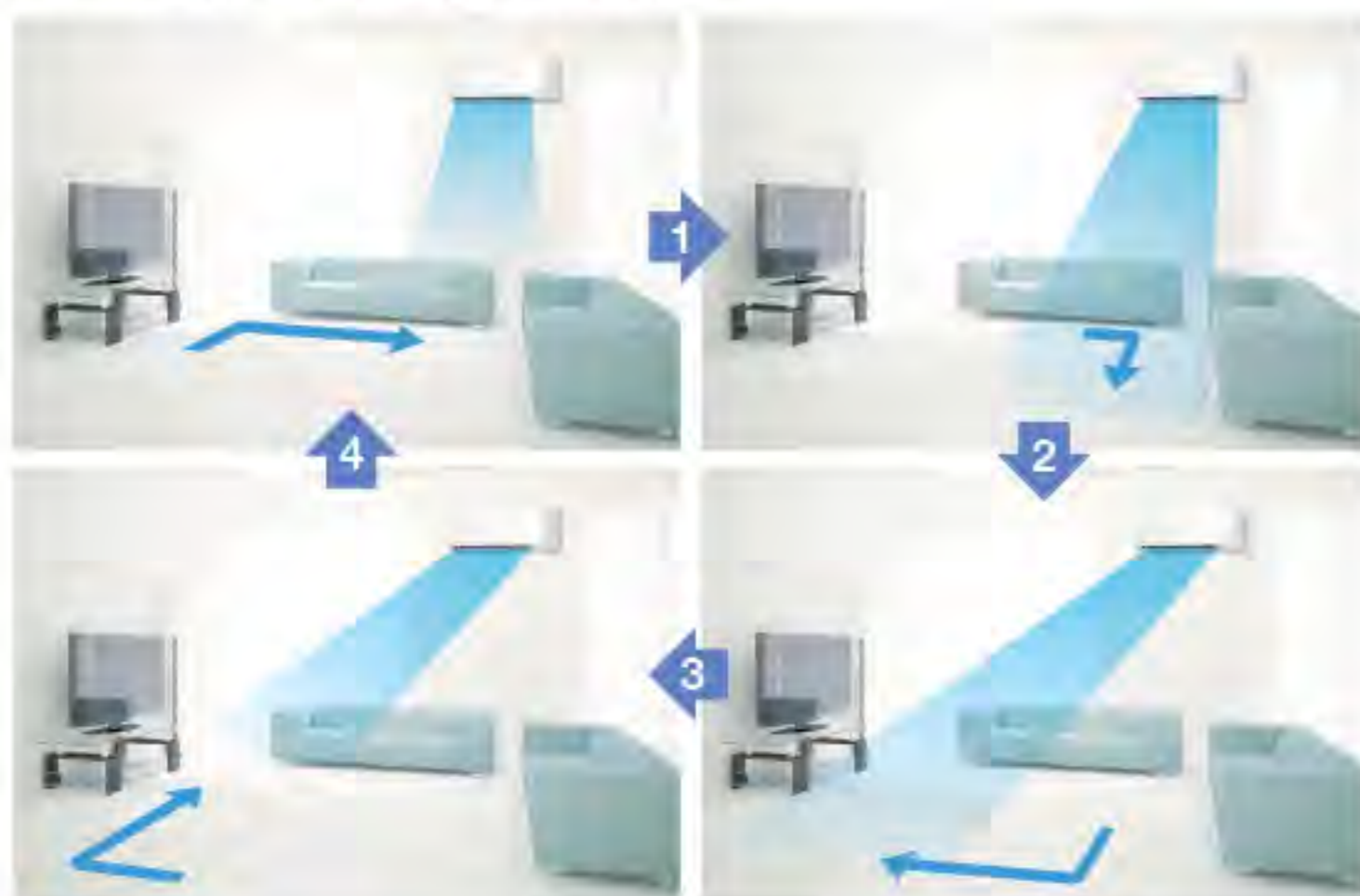

- ◆ Comfort airflow mode for cooling

*Applicable when wireless remote controller is used.

This function prevents uncomfortable cold drafts from blowing directly to the body. To prevent drafts, the flap moves upward during cooling operation.



- ◆ Switchable fan speed

5 steps, Quiet (SL), and Auto are selectable. Quiet operation (SL) is available when wireless remote controller is used.

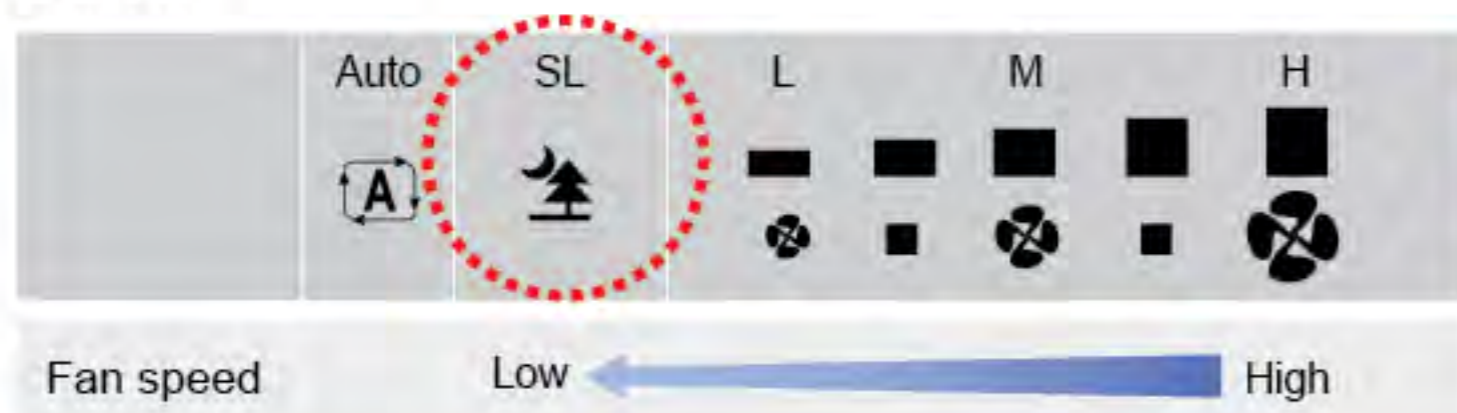

Sensing Sensor Function

- ◆ Auto energy saving by Intelligent Eye

*Applicable when wireless remote controller is used.

When human presence is not detected for 20 minutes, the temperature is adjusted approximately 2°C for energy saving.

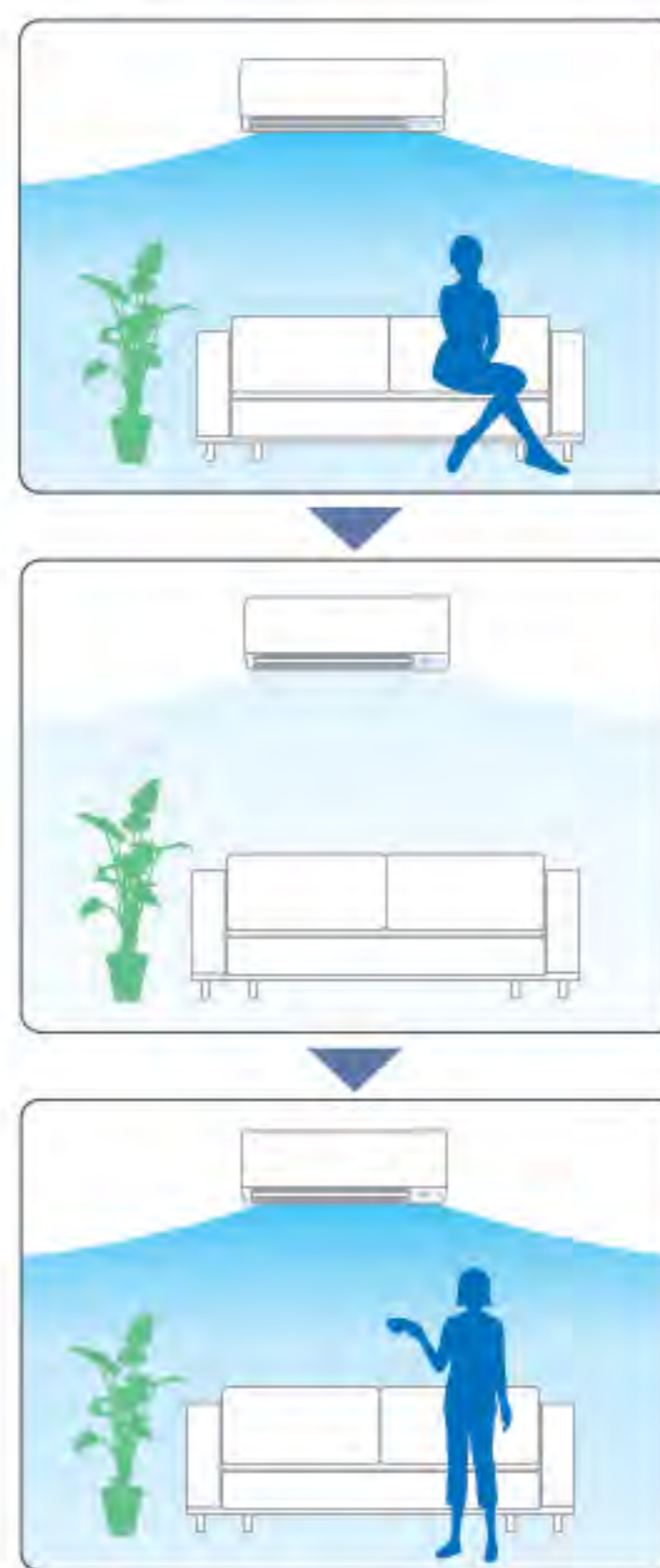

Easy Cleaning

- ◆ Removable and washable grille

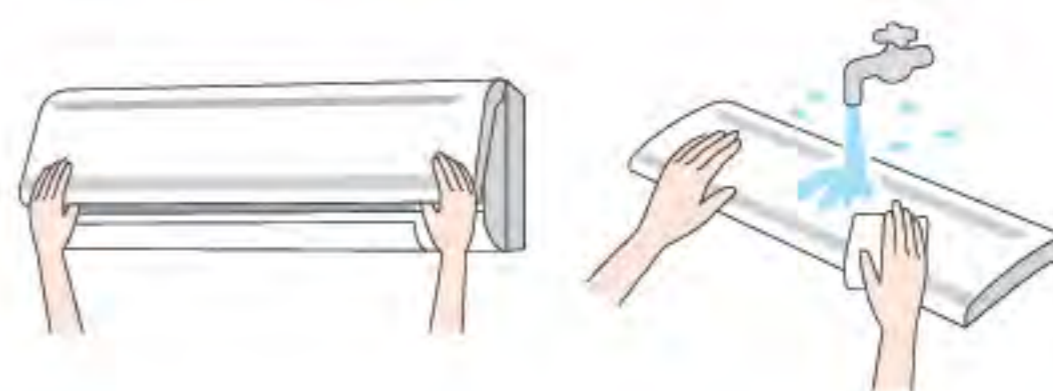

- ◆ Flat panel, easy to wipe dust off
- ◆ Non-flocking flaps

Condensation does not easily form and dirt does not cling to non-flocking flaps. It is easy to clean.

Installation Flexibility

- ◆ 6-direction refrigerant piping offers greater installation flexibility

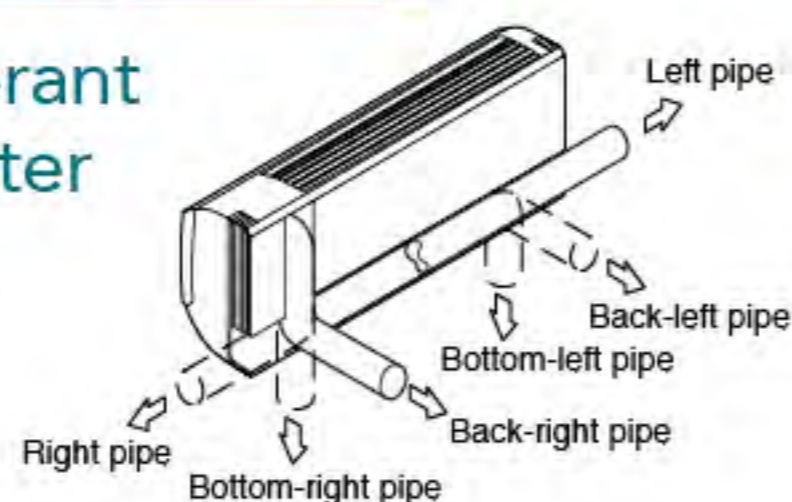

- ◆ Maintenance possible from the front of the unit

All maintenance tasks can be carried out via front access. During servicing, attachment and detachment of parts is easier.

Compact Outdoor Unit

RZF series
Cooling only



RZF50CV1G
RZF60CV1G
RZF71CV1G



RZF100CV1G



RZF125CV1G

RZFC series
Cooling only



RZFC35EV1G



RZFC50DV1G
RZFC60DV1G
RZFC71DV1G



RZFC100DV1G
RZFC100DY1G



RZFC125DV1G
RZFC125DY1G
RZFC140DV1G
RZFC140DY1G

Easy Installation and Maintenance

◆ 4-direction piping offers greater layout freedom (RZF125, RZFC125/140)

The outer panel for the piping connection part of the front, right side and backside can be removed and is easier for post-installation piping work.

◆ Removable part of bottom frame makes the piping work easier (RZF125, RZFC125/140)

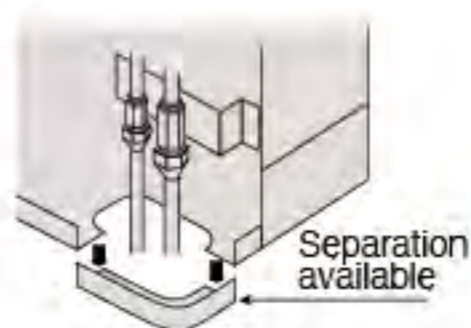

◆ Facilitates pump down (Refrigerant recovery function)

A pump-down switch is provided to make it easier to collect refrigerant if the unit is to be moved or layout modified.

*Pump-down function is available for pre-charged refrigerant amount.

*Although pumping-down operation allows most of the refrigerant to be recovered in a short period of time, some refrigerant will remain inside the indoor unit and refrigerant piping.

Using a refrigerant recovery machine, recover remaining refrigerant from the stop valve service port until the pressure falls to 0.09 MPa. (gauge pressure: -0.011MPa) or less.

◆ Low gas pressure detection function

Effective gas monitoring reduces the labor required for operation, maintenance, and repairs.

Night Quiet Operation Mode

RZF series

The automatic night quiet mode will initiate 8 hours after the peak temperature is reached in the daytime, and normal operation will resume 10 hours after that.

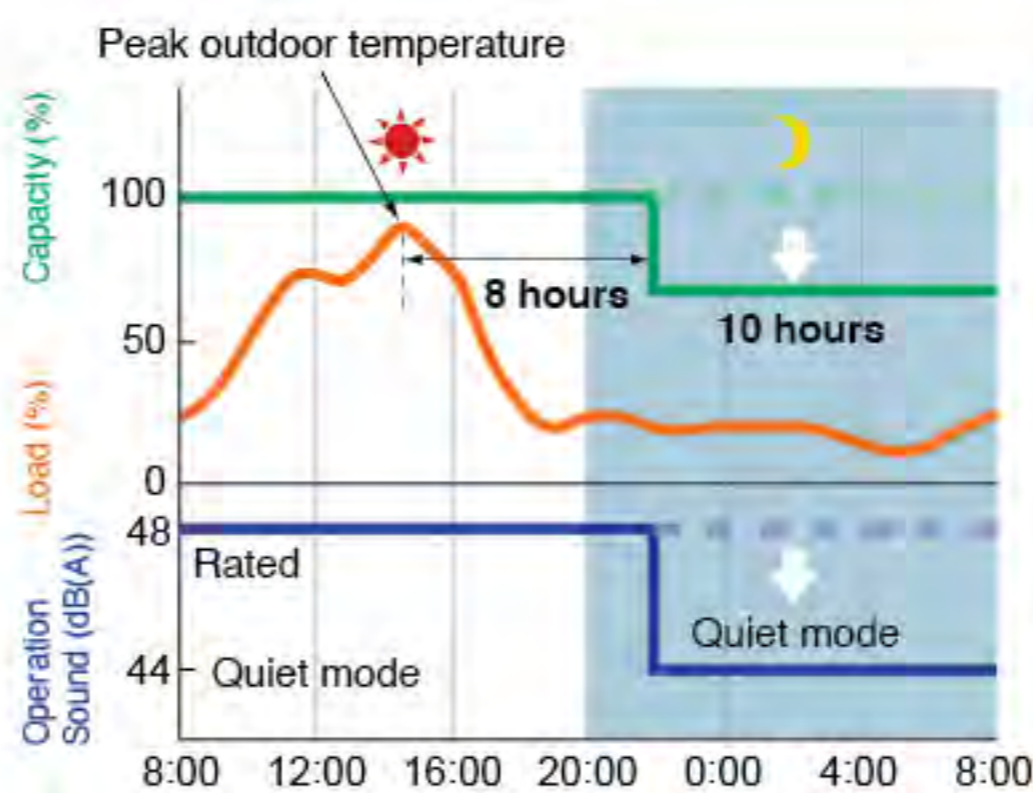

Note :
Daikin date for RZF71C
Operating sound about 4 dB quieter

		Sound pressure level ¹ (dB(A))	
		Rated	Night Quiet Mode
RZF	50-71C	48	44
	100C	49	45
	125C	52	48

★ Reducing noise will reduce capacity slightly.

Note :

¹Anechoic chamber conversion value, measured according to JIS parameters and criteria. During operation these values are somewhat higher owing to ambient conditions.

Reuse of Existing Piping: Refrigerant Pipe Size Table

RZF series

Outdoor Unit		Existing pipe size (Liquid / Gas)	6.4 / 12.7	6.4 / 15.9	9.5 / 12.7	9.5 / 15.9	9.5 / 19.1	12.7 / 15.9	12.7 / 19.1	Level difference	Design pressure (High pressure)
RZF50-71CV1G	9.5 / 15.9	Condition	■	▲	■	◎	×	△	×	Max. 30m	4.17MPa
		Max. piping length	10m*	10m*	50m	50m	—	25m	—		
		Chargeless piping length	10m	10m	30m	30m	—	15m	—		
RZF100/125CV1G	9.5 / 15.9	Condition	■	▲	■	◎	○	△	△	Max. 30m	4.17MPa
		Max. piping length	10m*	10m*	50m	50m	50m	25m	25m		
		Chargeless piping length	10m	10m	30m	30m	30m	15m	15m		

- ◎ Standard pipe size
- Same condition with standard pipe
- △ Piping length and chargeless piping length are shortened
- Cooling capacity is lowered (pay attention to piping length)
- ▲ Piping length and chargeless piping length are much shortened
- × Reuse of existing piping is not allowed

★ The allowable minimum piping length is 5 m.

- Refer to the installation manual for details other than those mentioned in the left table such as additional refrigerant charge amount.
- Clean the existing piping if its length exceeds 30m.
- Clean the existing piping if existing piping length exceeds limit of chargeless piping length to perform pump-down refrigerant recovery.

Technology for energy efficiency

The high efficiency compressor to achieve a high COP

1 Compressor equipped with reluctance DC motor

Daikin DC Inverter models are equipped with the reluctance DC motor for compressor. The reluctance DC motor uses 2 different types of torque, neodymium magnet^{*1} and reluctance torque^{*2}. This motor can save energy because it generates more power with a smaller electric power than an AC or previous DC motor.

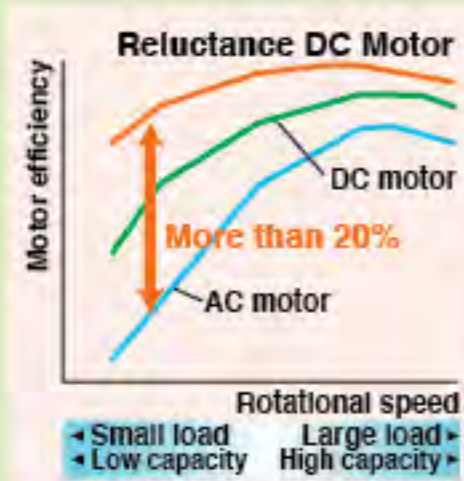

Note: Data are based on studies conducted under controlled conditions at a Daikin laboratory.



- *1. A neodymium magnet is approximately 10 times stronger than a standard ferrite magnet.
- *2. The torque created by the change in power between the iron and magnet parts.



Swing compressor

High efficiency during partial load operation.

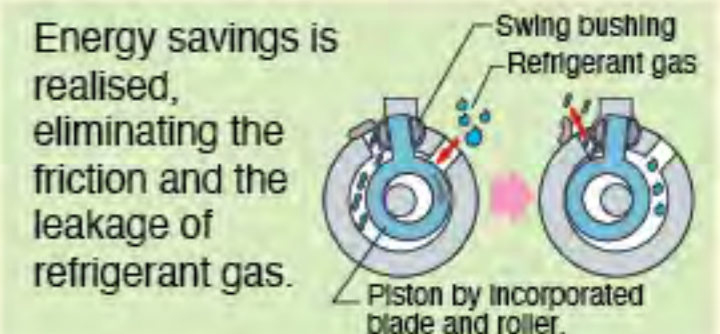

2 Refrigerant cooling

(RZF100/125, RZFC100DY1G, RZFC125/140)

Daikin's unique refrigerant cooling system exhibits high cooling capacity even during high outdoor temperatures.

Refrigerant cooling helps protect the printed circuit board and maintains high cooling capacity even during high outdoor temperatures.

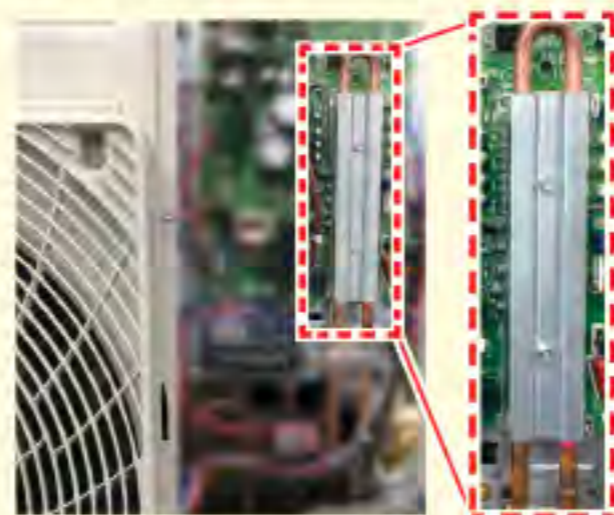

3 Fan

V-cut Propeller Fan (RZF50-100, RZFC35-100)

Through use of a V-cut propeller fan that imitates the efficiency of the swan, a migratory bird, airflow becomes smooth and loss is reduced.



V-cut propeller fan



Imitating the performance of the swan

4 High condensing capacity by micro channel heat exchanger

RZF series

RZFC50-140 series

Reduced wind resistance The flattening of the heat exchanger tubes improves the flow of air and increases heat exchange efficiency.

Conventional tube and fin coil



Flow of refrigerant

The diameter of the refrigerant channel (holes where refrigerant flows) is approx. 7mm



Micro channel coil

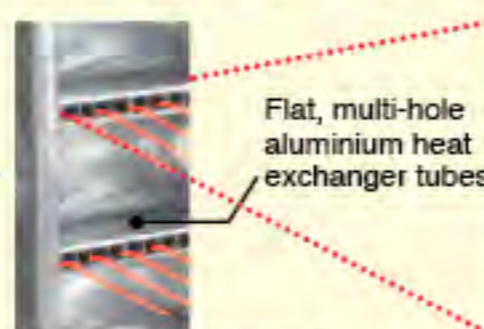

Flow of refrigerant

Flat, multi-hole aluminium heat exchanger tubes

The diameter of the refrigerant channel (holes where refrigerant flows) is approx. 1mm



Conventional heat exchanger

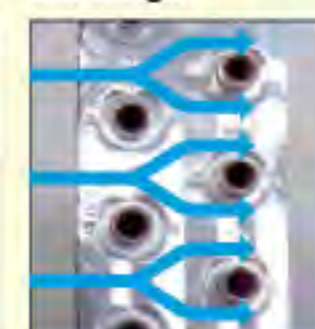

Micro channel heat exchanger



Utilizing flat, multi-hole heat exchanger tubes increases the heat exchange area and realizes energy savings.

Stylish Remote Controller (Wired Remote Controller)

*Except for FAFC series.

BRC1H61W/K



reddot design award



BRC1H61W (White)



BRC1H61K (Black)

Sleek Stylish Design

Much like the perfection of its circular shape, the remote controller gives you perfect control over your individual climate.

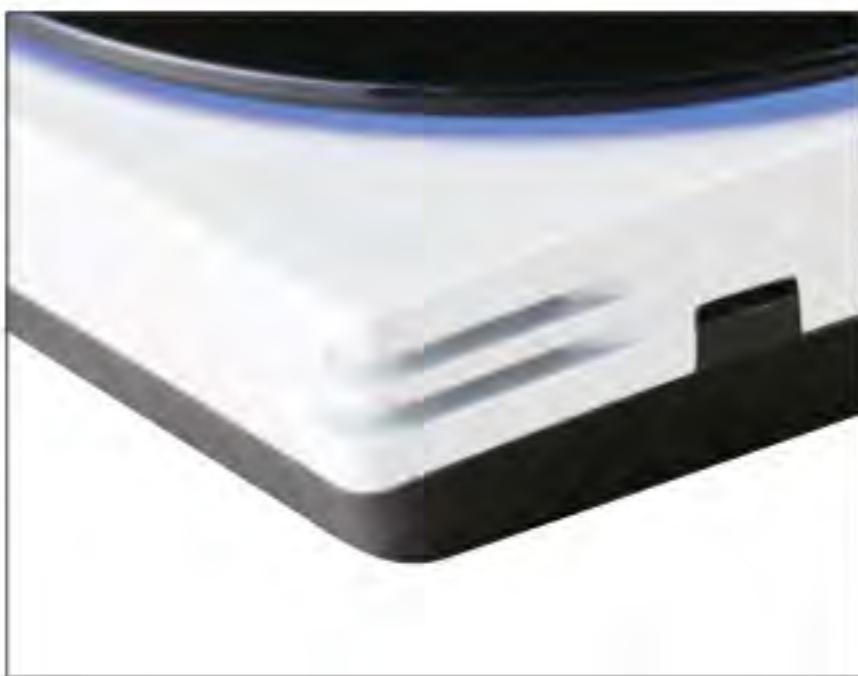

Navigation Remote Controller (Wired Remote Controller)

BRC1E63 BRC073A5 (for FAFC)

Operation is easy and smooth,
just follow the indications on the
navigation remote controller.



Energy saving

Setpoint auto reset

- Even if the set temperature is changed, the new set temperature returns to the previous preset value after a preset duration of time.
- Period selectable from 30, 60, 90, or 120 min.

Restaurant example

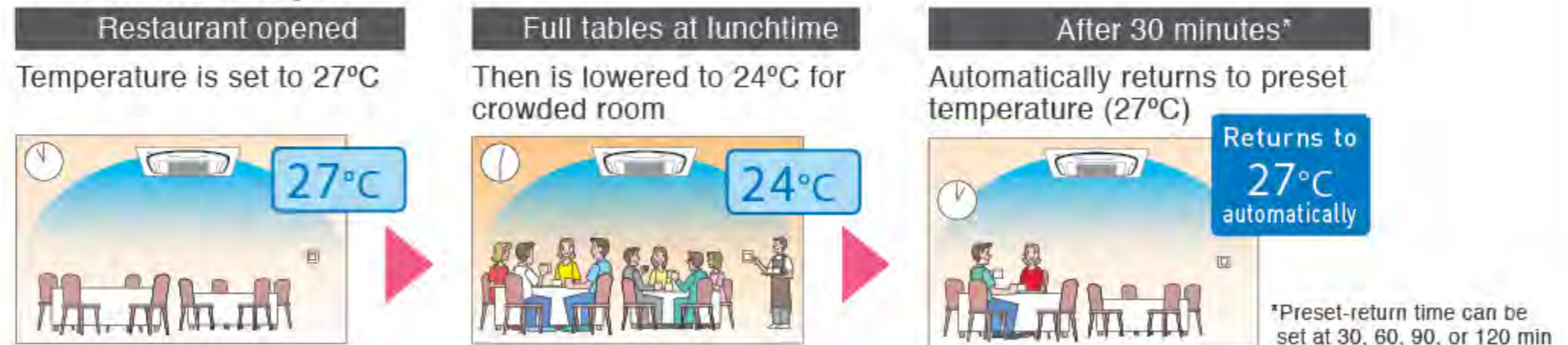

OFF timer (programmed)

- Sets and saves setting for an increment of time that automatically turns OFF air conditioner after a preset period of time for each time operation starts.
- Period can be preset from 30 to 180 minutes in 10-minute increments.

Setpoint range set

- Saves energy by limiting the min. and max. set temperature.
- Avoids excessive heating or cooling.
- This function is convenient if the remote controller is installed where anyone can change the settings.

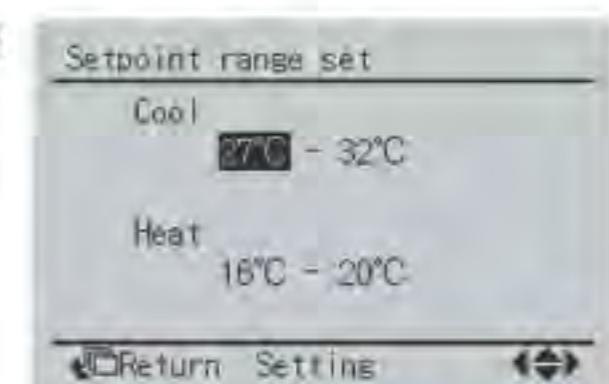

Convenience

5-step airflow control

- The number of airflow steps depends on the type of indoor unit.
- 5-step control applies to FCF and FAFC series.

Setback (default: OFF)

- Maintains the room temperature in a specific range during unoccupied periods by temporarily starting an air conditioner that had been turned OFF.

Energy consumption monitoring ^{*1,2,3,4}

- Past power consumption for the current and previous days (2-hour intervals), week (1-day intervals), and year (1-month intervals) can be checked.

Note:

- ^{*1}Availability of this function may vary according to model (limited to partial functionality)
- ^{*2}Time setting is necessary.
- ^{*3}This function cannot be used during group control.
- ^{*4}This is a reference value for comparison and is not intended as a value for investigation purposes in the calculation of electricity bills or contract for electricity. Because it is a simple calculation of power consumption, there are cases when the calculated value differs with the measurement results of a wattmeter.

Weekly schedule

- 5 actions per day can be scheduled for each day of the week.
- The holiday function will disable schedule timer for the days that have been set as holiday.
- 3 independent schedules can be set. (e.g. summer, winter, mid-season)

Time	Act	Cool	Heat
8:30	ON	25°C	—
10:00	OFF	—	—
13:00	ON	25°C	—
15:00	OFF	—	—

Auto display off

- While operation is stopping, LCD display can be turned OFF. It will be displayed again if any button is pressed.
- Period can be preset from 10, 30, 60 minutes, and OFF. Initial setting is 30 minutes.

Simplified Remote Controller (Wired Remote Controller)

*Except for FAFC series.

BRC2E61



Simple operation

Using only six buttons, users have direct access to basic functions. This enables them to easily set comfort to their preference.

Intuitive design

By using pictograms, the user-friendly interface enables:

- Overseas guests at hotels to understand functions without having to know a foreign language.
- Children and elderly users at home to operate without having to read difficult and hard-to-see commands.

Compact

Measuring only 85 x 85 mm, the new remote controller is extremely compact and complements any interior design.

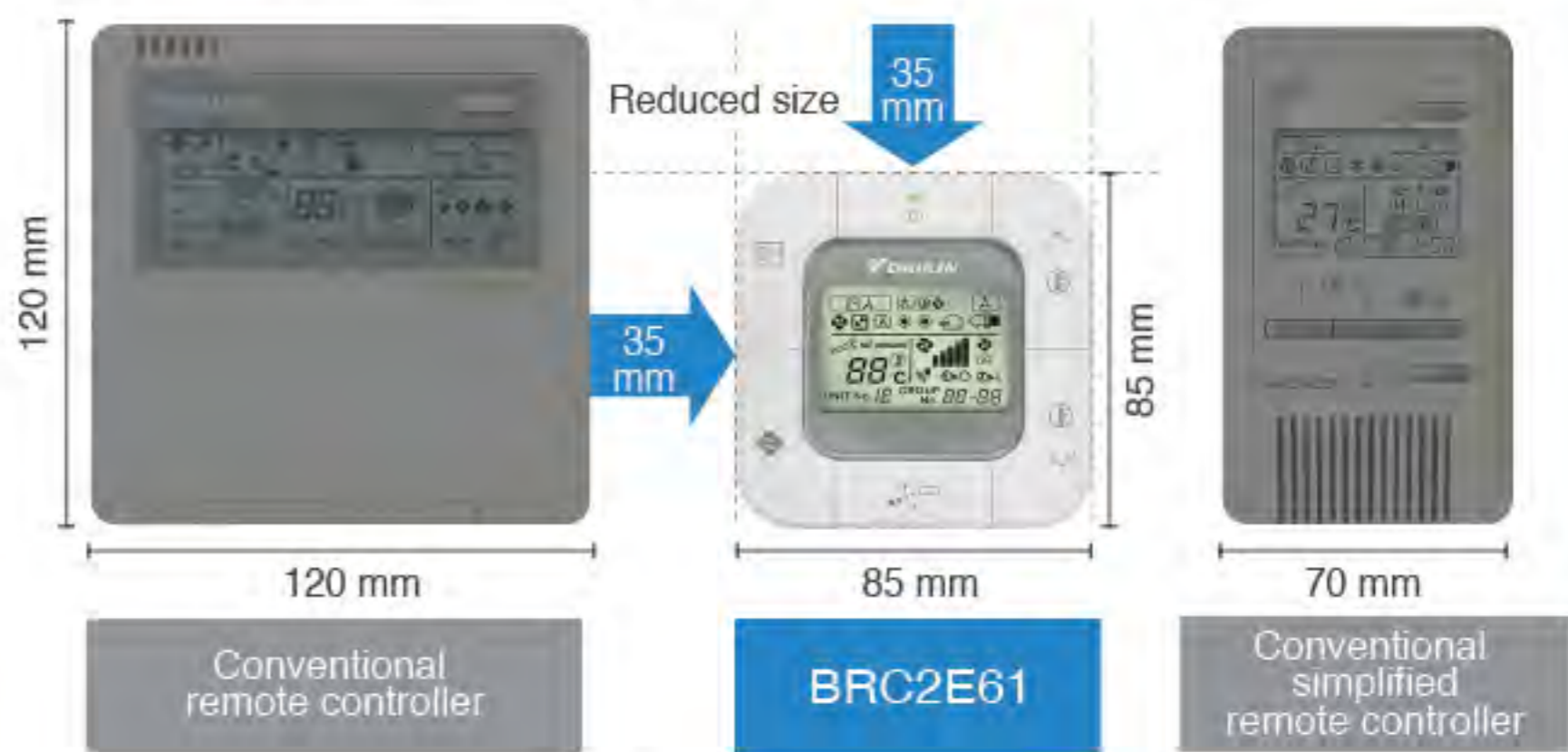

Wireless Remote Controller



BRC7M635F

Signal receiver unit
(For ceiling mounted
cassette type)

- The wireless remote controller is supplied in a set with a signal receiver.
- Signal receiver unit of installed type is contained inside decoration panel or indoor unit.
- Shape of signal receiver unit differs according to the indoor unit.

Note: The signal receiver unit shown in the photograph is for mounting inside the decoration panel of the ceiling mounted cassette type.

- Backlight LCD of new wireless remote controller



Pressing the backlight button helps operating in dark rooms.

Wireless remote controller for each indoor unit type



	Cooling only
CEILING MOUNTED CASSETTE TYPE	BRC7M635F(K)
COMPACT MULTI FLOW CEILING MOUNTED CASSETTE TYPE	BRC7M531W
DUCT CONNECTION MIDDLE STATIC PRESSURE TYPE	BRC4C66
CEILING SUSPENDED TYPE	BRC7EA66 (FHFC50-71D series) BRC7GA56 (FHFC100-140D series)
WALL MOUNTED TYPE	ARC466A14 (Standard option)

Wired remote controller has built-in temperature-sensor

- Enables temperature sensing closer to target area for improved comfort. (When using a remote control from another room, temperature-sensor of the indoor unit air inlet must be selected.)

Facilitates maintenance and repair

- All initial settings can be set from the remote controller. After interior construction is complete, ceiling mounted cassette type can be remotely set without having to use a stepladder to access for manual setting.
Setting contents: High ceiling use, air direction, filter type, address for centralised control (group control address is set automatically), etc.
- Remote controller is equipped with error code display functions. This facilitates service in the unlikely event of a malfunction.
*Model name display function applies to BRC1E63 only. (Some models show their model code.)



SkyAir shares common control with Heat Reclaim Ventilator and the other Daikin air-conditioning units, thus simplifying interlocking operations.

- Easily adaptable to large-scale, high-function, centralised remote control systems.
Installing and connecting control wiring between SkyAir and other Daikin air-conditioning equipment is easy.

LCD panel shows operating status in letters, numbers, and motion.

Airflow / swing display	Displays auto-swing operating status and setting position of air discharge angle.
Preset temperature / operation mode display	Displays preset room temperature and operating status (fan, dry, cool).
Programming time display	Operation start and stop time can be set for individual timers up to 72 hours. The LCD also shows when it is time to clean the filter, when changeover is under centralised control, and ventilation/cleaning.
Self-diagnosis function	Monitors operating status within the system covering 40 items, and displays a message to indicate as soon as a malfunction occurs.

System variation to control multiple indoor units

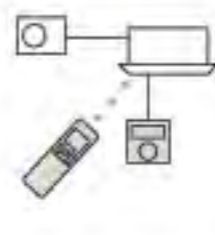
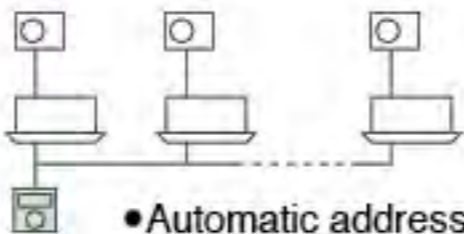
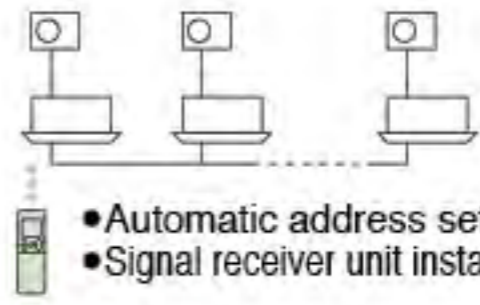
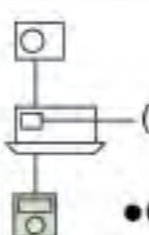
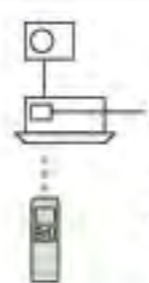
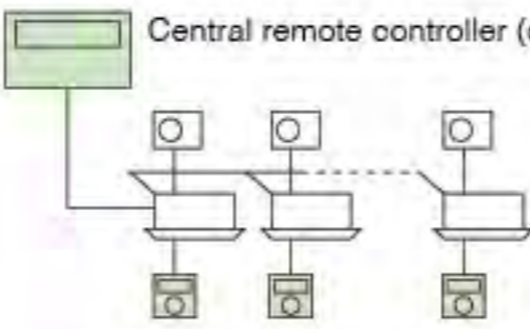
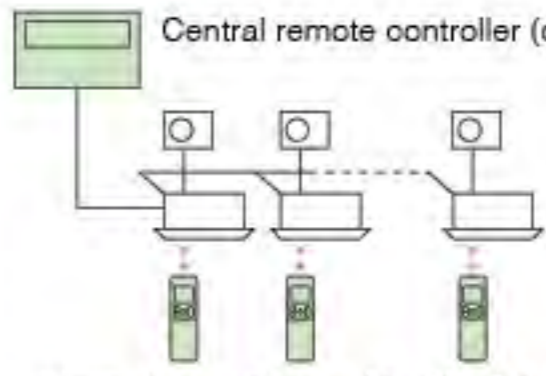
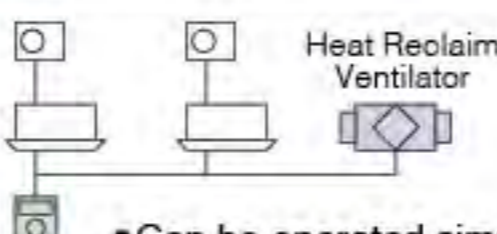
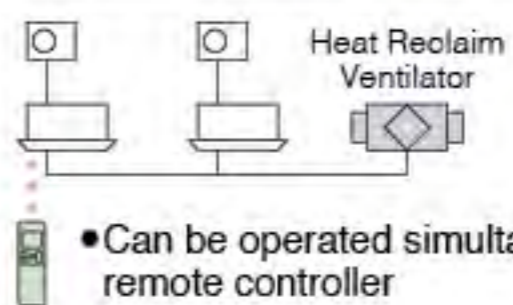
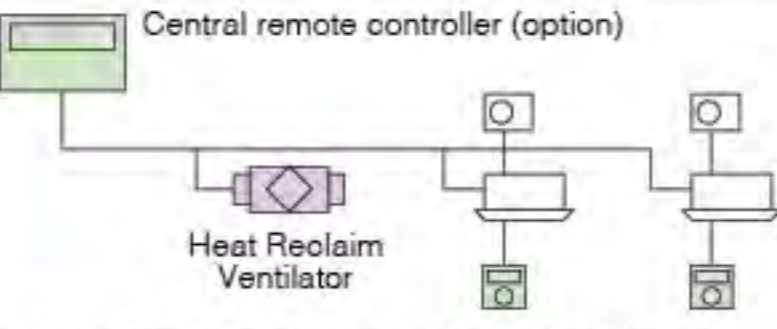
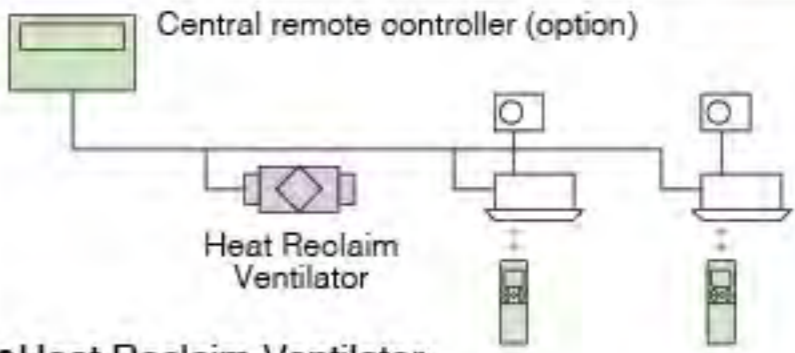
	Control pattern	Wired remote controller	Wireless remote controller
Control by 1 remote controller	(Basic system)	 <ul style="list-style-type: none"> • Non-polar, double-core (max. wiring length 500 m) 	 <ul style="list-style-type: none"> • Signal receiver unit installed on indoor unit
Control by 2 remote controllers	For control from 2 locations such as in room and control room, exits, etc.	 <ul style="list-style-type: none"> • Connects 2 wired remote controllers (See note 1) 	 <ul style="list-style-type: none"> • Control by 1 wireless remote controller and 1 wired remote controller (See note 2 and 3) • Signal receiver unit installed on indoor unit
Group control	For simultaneous control of up to 16 indoor units.	 <ul style="list-style-type: none"> • Automatic address setting function 	 <ul style="list-style-type: none"> • Automatic address setting function • Signal receiver unit installed on 1 indoor unit
Control by external command	Operation and monitoring is carried out using the contact signal from the operation control box in the monitoring room.	 <p>(Command from outside)</p> <ul style="list-style-type: none"> • Optional wiring adaptor for electrical appendices is necessary 	 <p>(Command from outside)</p> <ul style="list-style-type: none"> • Optional wiring adaptor for electrical appendices is necessary
Centralised remote control	Centralised control of up to 64 indoor groups from remote location up to 1 km away.	 <p>Central remote controller (option)</p> <ul style="list-style-type: none"> • Interface adaptor for SkyAir series (option) is required (See note 4) 	 <p>Central remote controller (option)</p> <ul style="list-style-type: none"> • Interface adaptor for SkyAir series (option) is required (See note 4)
Interlock control with Heat Reclaim Ventilator	Link by remote controller group control.	 <p>Heat Reclaim Ventilator</p> <ul style="list-style-type: none"> • Can be operated simultaneously or independently by remote controller (set by ventilation mode) 	 <p>Heat Reclaim Ventilator</p> <ul style="list-style-type: none"> • Can be operated simultaneously by remote controller
	Zone link control by centralised control.	 <p>Central remote controller (option)</p> <p>Heat Reclaim Ventilator</p> <ul style="list-style-type: none"> • Heat Reclaim Ventilator for indoor units within a zone is operated by interlocking. Can also be operated independently by remote controller. 	 <p>Central remote controller (option)</p> <p>Heat Reclaim Ventilator</p> <ul style="list-style-type: none"> • Heat Reclaim Ventilator for indoor units within a zone is operated by interlocking.

Note: ¹Available combinations: 1) BRC1H61W(K) (main) and BRC1H61W(K) (sub) 2) BRC1E63 (main) and BRC1E63 (sub) 3) BRC2E61 (main) and BRC2E61 (sub) 4) BRC1E63 (main) and BRC2E61 (sub)
²When a wireless remote controller is used, it is not possible to use 2 wireless remote controllers.
³Available combinations: Please refer to table*9 on page 46. ⁴FHFC50-71 requires interface adaptor for SkyAir series.

Easily adaptable to large-scale, high-function, centralised remote control system.

<p>Central remote controller</p> <p>DCS302CA61 (Option)</p>  <p>Centralised control, with setting as simple as it is with a standard remote controller, of up to 64 groups (1,024 indoor units) is possible.</p>	<p>Unified on/off controller</p> <p>DCS301BA61 (Option)</p>  <p>Centralised control of on/off by group or all at once for up to 256 indoor units.</p>	<p>Schedule timer</p> <p>DST301BA61 (Option)</p>  <p>Unified control of weekly schedule for up to 1,024 indoor units.</p> <p>Schedule timer sets on/off time in 1 minute units to be executed twice a day for a week at a time.</p>	<p>Intelligent Controller</p> <p>DCS601C51 (Option)</p>  <p>With its high functionality, the full colour "all-in-one" graphic controller facilitates management of SkyAir System in a variety of ways.</p>	<p>Smart Control SVM</p> <p>SVMPC1</p>  <p>Centralised control and monitor with this smart hub for SkyAir units and other integrated smart devices from smart phone or tablet.</p>
--	---	--	--	--

Interface adaptor for SkyAir series
 DTA112BA51 (Option)
 DTA116A51 (Option)

Enables centralised control via connection to a high-speed, DIII-NET communication system, adopted for the Daikin VRF system.
 Necessary for interface adaptor for SkyAir series with the central remote control units shown at above.

- The interface adaptor for SkyAir series is required for Ceiling suspended type 50-71 class.



Whatever your space, give it the comfort it deserves



Functions overview

Cooling only

		CEILING MOUNTED CASSETTE TYPE (Round Flow)					
		FCF50-125CVMG			FCFC100-140DVMG		
		RZF50-125CV1G			RZFC100-140DY1G		
		BRC1E63	BRC2E61	—	BRC1E63	BRC2E61	—
		—	—	BRC7M635F (K)	—	—	BRC7M635F (K)
		Indoor unit		Outdoor unit		Remote controller	
		Wired		Wireless			
Energy Saving	1	Energy consumption monitoring *1	●				
	2	Sensing sensor stop mode *1	● Sensing panel			● Sensing panel	
	3	Sensing sensor low mode *1, 2	● Sensing panel			● Sensing panel	
	4	Auto display OFF *1	●			●	
	5	Setpoint auto reset *1	●			●	
	6	Setpoint range set *1	●			●	
	7	OFF timer (programmed) *1	●			●	
	8	Weekly schedule timer *1	●			●	
	9	ON/OFF timer		●	●		●
	10	Econo mode					
Comfort	11	Circulation airflow *1	●			●	
	12	Setback *1	●			●	
	13	Quick start *1	●				
	14	Individual airflow control *1	●			●	
	15	Infrared presence sensor		● Sensing panel			● Sensing panel
	16	Infrared floor sensor		● Sensing panel			● Sensing panel
	17	Auto airflow function (Direct air, Draft prevention) *1	● Sensing panel			● Sensing panel	
	18	Comfort airflow mode					
	19	Auto swing	●	●	●	●	●
	20	Swing pattern selection	●	●	●	●	●
	21	Switchable fan speed	● 5 step	● 5 step	● 5 step	● 3 step	● 3 step
	22	Auto airflow rate	●	●	●	●	●
	23	Two selectable temperature-sensors *3	●	●		●	●
	24	High ceiling application	● 3.5 m / 4.2 m	● 3.5 m / 4.2 m	● 3.5 m / 4.2 m	● 4.2 m	● 4.2 m
	25	Night quiet operation *4	●				
	26	Indoor unit quiet operation					
	27	Outdoor unit quiet operation					
Cleanliness	28	Anti-bacterial air filter		●		●	
	29	Mould-proof air filter					
	30	Silver ion anti-bacterial drain pan		●		●	
	31	Dust collection filter (PM2.5)					
Work & Servicing	32	Auto grille panel		● *7		● *7	
	33	Drain pump mechanism		●		●	
	34	Pre-charged for up to 10/15 m *4		● 30 m		●	
	35	Long-life filter		● *7		● *7	
	36	Filter sign	●		●	●	●
	37	Low gas pressure detection *4		●		●	
	38	Emergency operation		●		● *8	
	39	Self-diagnosis function	●	●	●	●	●
	40	Service contact display *1	●			●	
	Control	41	Auto-restart		●		●
42		Control by 2 remote controllers	● *9	● *9	● *9	● *9	● *9
43		Group control by 1 remote controller	●	●	●	●	●
44		External equipment interlock *5		● Sensing panel			
45		External signal forced OFF and ON/OFF operation		●		●	
46		External command control *6		●		●	
47		Central remote control		●		●	
48		Interlock control with Heat Reclaim Ventilator		●		●	
49		DIII-NET communication standard		●		●	
Options ⁷	50	High-efficiency filter		●		●	
	51	Ultra long-life filter		●		●	
	52	Fresh air intake kit		●		●	
	53	Overvoltage PCB *4		●			

COMPACT MULTI FLOW CEILING MOUNTED CASSETTE TYPE			DUCT CONNECTION MIDDLE STATIC PRESSURE TYPE		
 FFFC35/50AVMG			 FBFC50-140DVMG		
RZFC35EV1G RZFC50DV1G			RZFC50-140DV1G RZFC100-140DY1G		
BRC1E63	BRC2E61	— BRC7M531W	BRC1E63	BRC2E61	— BRC4C66
1			●*10		
2	● Sensor kit				
3	● Sensor kit				
4	●		●		
5	●		●		
6	●		●		
7	●		●		
8	●		●		
9		●		●	●
10					
11					
12	●		●		
13					
14	●				
15		● Sensor kit			
16		● Sensor kit			
17	● Sensor kit				
18					
19	●	●	●		
20	●	●	●		
21	● 3 step	● 3 step	● 3 step	● 3 step	● 3 step
22	●	●	●	●	●
23	●	●	●	●	
24	● 3.5 m	● 3.5 m	● 3.5 m		
25					
26					
27					
28		●		●*7	
29					
30				●	
31					
32					
33		●		●*7	
34		●		●	
35		●*7		●*7	
36	●		●	●	●
37		●		●	
38				●*8	
39	●	●	●	●	●
40	●		●		
41		●		●	
42	●*9	●*9	●*9	●*9	●*9
43	●	●	●	●	●
44					
45		●		●	
46		●		●	
47		●		●	
48		●		●	
49		●		●	
50				●	
51					
52		●			
53					

Note:

- *1: Applicable when BRC1E63 is used.
- *2: Not applicable when group control.
- *3: Applicable when wired remote controller is used.
- *4: For outdoor units.
- *5: Adaptor for Wiring (and installation box) is necessary. (Option)
- *6: Wiring adaptor for electrical appendices (and installation box) is necessary. (Option)
- *7: Option is required.
- *8: For 3-phase outdoor unit RZFC-DY1G only.
- *9: Available combinations are ● in the table*9.
- *10: Applicable when RZFC125/140DV1G is used.

● Possible

Table *9		Main		
		Wired remote controller		
		(Option) BRC 1H61W(K)	BRC 1E63	(Option) BRC 2E61
Sub	Wired remote controller	BRC 1H61W(K)	●	
		BRC1E63		●
		BRC2E61		●
Sub	Wireless remote controller	BRC4C* BRC7C /E/F/G*		●
		BRC7M* BRC4M*		●

Functions overview

Cooling only

		CEILING SUSPENDED TYPE					
		FHFC50-71DV1G			FHFC100-140DV1G		
		RZFC50-71DV1G			RZFC100-140DV1G RZFC100-140DY1G		
		BRC1E63	BRC2E61	—	BRC1E63	BRC2E61	—
		—	—	BRC7EA66	—	—	BRC7GA56
		Indoor unit			Outdoor unit		
		Remote controller			Wired Wireless		
Energy Saving	1	Energy consumption monitoring *1				● *12	
	2	Sensing sensor stop mode *1					
	3	Sensing sensor low mode *1, 2, 3					
	4	Auto display OFF *1	●			●	
	5	Setpoint auto reset *1, 4	●			●	
	6	Setpoint range set *1, 4	●			●	
	7	OFF timer (programmed) *1, 4	●			●	
	8	Weekly schedule timer *1	●			●	
	9	ON/OFF timer		●	●		●
	10	Econo mode *3					
Comfort	11	Circulation airflow *1					
	12	Setback *1, 4	●			●	
	13	Quick start *1, 3					
	14	Individual airflow control *1					
	15	Infrared presence sensor *3					
	16	Infrared floor sensor					
	17	Auto airflow function (Direct air, Draft prevention) *1					
	18	Comfort airflow mode *3					
	19	Auto swing	●	●	●	●	●
	20	Swing pattern selection					
	21	Switchable fan speed	● 2 step	● 2 step	● 2 step	● 3 step	● 3 step
	22	Auto airflow rate				●	●
	23	Two selectable temperature-sensors *5	●	●		●	●
	24	High ceiling application	● 3.5 m	● 3.5 m	● 3.5 m	● 4.3 m	● 4.3 m
	25	Night quiet operation *6					
	26	Indoor unit quiet operation *3					
	27	Outdoor unit quiet operation *3					
Cleanliness	28	Anti-bacterial air filter		●		●	
	29	Mould-proof air filter					
	30	Silver ion anti-bacterial drain pan					
	31	Dust collection filter (PM2.5)					
Work & Servicing	33	Auto grille panel					
	34	Drain pump mechanism		● *9		● *9	
	35	Pre-charged for up to 10/15 m *6		●		●	
	36	Long-life filter		●		●	
	37	Filter sign	●		●	●	●
	38	Low gas pressure detection *6		●		●	
	39	Emergency operation				● *10	
	40	Self-diagnosis function	●	●	●	●	●
	41	Service contact display *1, 4	●			●	
	Control	42	Auto-restart		●		●
43		Control by 2 remote controllers	● *11	● *11	● *11	● *11	● *11
44		Group control by 1 remote controller	●	●	●	●	●
45		External equipment interlock *7					
46		External signal forced OFF and ON/OFF operation				●	
47		External command control *8		●		●	
48		Central remote control		● *9		●	
49		Interlock control with Heat Reclaim Ventilator		●		●	
50		DIII-NET communication standard		● *9		●	
Options ⁷		51	High-efficiency filter				
	52	Ultra long-life filter					
	53	Fresh air intake kit				●	
	54	Overvoltage PCB *6					

WALL MOUNTED TYPE	
FAFC100AV1G	
RZFC100DV1G	
BRC073A5	
ARC466A14	
1	
2	
3	● Intelligent eye (auto energy saving)
4	
5	●
6	●
7	●
8	● ●
9	● ●
10	●
11	
12	●
13	●
14	
15	●
16	
17	
18	●
19	● Up/Down, Left/Right ● Up/Down, Left/Right
20	
21	● 5 step ● 5 step+quiet
22	● ●
23	
24	
25	
26	●
27	●
28	
29	●
30	
31	● *9
33	
34	
35	●
36	
37	
38	
39	
40	● ●
41	●
42	●
43	
44	
45	
46	
47	
48	●
49	
50	
51	
52	
53	
54	

Note:

- *1: Applicable when BRC1E63 is used.
- *2: Not applicable when group control.
- *3: Applicable when ARC466A14 is used.
- *4: Applicable when BRC073A5 is used.
- *5: Applicable when wired remote controller is used.
- *6: For outdoor units.
- *7: Adaptor for Wiring (and installation box) is necessary. (Option)
- *8: Wiring adaptor for electrical appendices (and installation box) is necessary. (Option)
- *9: Option is required.
- *10: For 3-phase outdoor unit RZFC-DY1G only.
- *11: Available combinations are ● in the table*11.
- *12: Applicable when RZFC125/140DV1G is used.

● Possible

Table *11		Main		
		Wired remote controller		
		(Option) BRC1H61W(K)	BRC1E63	(Option) BRC2E61
Sub	Wired remote controller	BRC1H61W(K)	●	
		BRC1E63		●
		BRC2E61		● ●
	Wireless remote controller	BRC4C* BRC7C/E/F/G*		●
BRC7M* BRC4M*			● ●	

Abundance of functions that provide comfortable air-conditioning in stores and offices

Note: Some features are only available on selected models. See overview pages for full list of features applicable to each unit.

Energy Saving

1. Energy consumption monitoring

Past power consumption is displayed for the current and previous days as well as in weekly and yearly intervals.

2. Sensing sensor stop mode

When the room is unoccupied, the system stops automatically.

3. Sensing sensor low mode

When the room is unoccupied, the set temperature is shifted automatically.

4. Auto display OFF

While operation is stopping, the LCD display can be turned off. It can be displayed again when any button is pressed.

5. Setpoint auto reset

Even if the set temperature is changed, the new set temperature returns to the previous preset value after a preset duration of time.

6. Setpoint range set

Saves energy by limiting the minimum and maximum set temperatures. Avoids excessive heating and cooling.

7. OFF timer (programmed)

Sets and saves setting for an increment of time that automatically turns off air conditioner after a preset period of time for each time operation starts.

8. Weekly schedule timer

Up to five operation ON/OFF settings can be programmed per day for each day of the week. Not only can the time be set for the operation ON setting, but also the temperature.

9. ON/OFF timer

Operation starts when the preset time of the ON timer elapses and stops when the preset time of the OFF timer elapses.

10. Econo mode

This mode limits maximum power consumption. This improves operating efficiency and also prevents circuit breakers from being overloaded.

Comfort

11. Circulation airflow

At the start of operation, airflow changes repeatedly between horizontal flow and downward flow (swing during cool operation), and air is sent throughout the room to eliminate uneven temperatures.

12. Setback

Maintains the room temperature in a specific range during unoccupied periods by temporarily starting an air conditioner that had been turned OFF.

13. Quick start

At operation start, capacity priority operation is possible.

14. Individual airflow control

Airflow direction can be individually adjusted for each air discharge outlet to deliver optimal air distribution.

15. Infrared presence sensor

The sensor detects the presence of people in each of the 4 areas.

16. Infrared floor sensor

The sensor detects the floor temperature and automatically adjusts operation of the indoor unit to reduce the temperature difference between the ceiling and the floor.

17. Auto airflow function (Direct air, Draft prevention)

When this function is set, airflow direction can be directed toward or away from people when human presence is detected.

18. Comfort airflow mode

This function prevents uncomfortable drafts from blowing directly on to the body. To prevent drafts, the flap moves upward during cooling operation.

19. Auto swing

Delivers comfortable air-conditioning to all areas, near to and far from the air-conditioner.

- The air flow direction can be fixed at your desired angle by the remote controller.

20. Swing pattern selection

You can freely set air discharge settings by remote controller.

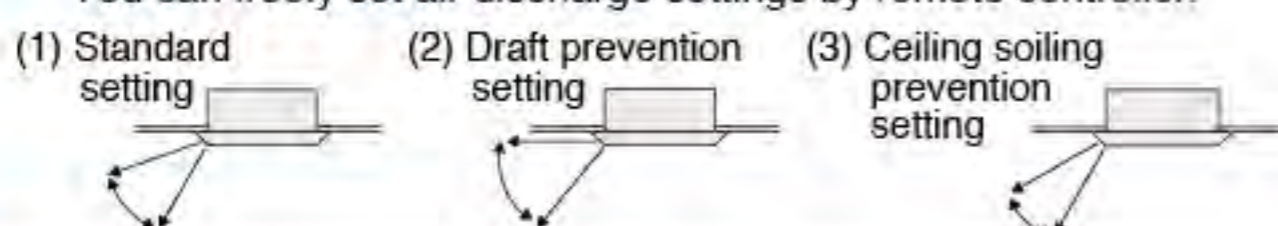

21. Switchable fan speed

High setting provides maximum reach while low setting minimises drafts.

22. Auto airflow rate

Airflow rate is automatically controlled in accordance with the difference between room temperature and set temperature.

23. Two selectable temperature-sensors

Temperature-sensors are included in the indoor unit and optional wired remote controller. Temperature sensing closer to target area is possible to further increase the comfort level.

- Use the temperature-sensor in the indoor unit when controlling air conditioning from another room.



Note: Wireless remote controllers have no temperature-sensor.

24. High ceiling application

Delivers air-conditioning comfort all the way down to the floor in air-conditioning zones with high ceilings.

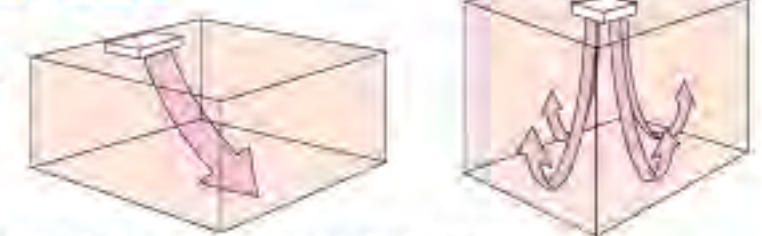

Note: When units are installed on high ceilings, depending on the model, various restrictions concerning maximum height, air discharge direction, and choice of options may apply.

25. Night quiet operation

The Automatic night quiet mode will initiate 8 hours after the peak temperature is reached in the daytime, and normal operation will resume 10 hours after that.

26. Indoor unit quiet operation

Indoor unit operating sound pressure levels can be decreased from the low setting fan speed using the wireless remote controller.

27. Outdoor unit quiet operation

Outdoor unit operating sound pressure levels can be decreased from the rated operation sound using the wireless remote controller.

Cleanliness

28. Anti-bacterial air filter

The air filter has an anti-bacterial treatment to help prevent the growth of bacteria and mould on it.

29. Mould-proof air filter

Sanitary filter has mould-resistant treatment.

30. Silver ion anti-bacterial drain pan

A built-in antibacterial treatment that uses silver ion in the drain pan prevents the growth of slime, bacteria, and mould that cause odours and clogging.

31. Dust collection filter (PM 2.5) (Option)

This filter removes PM 2.5, particulate matter which is smaller than 2.5 micrometres (μm). $1 \mu\text{m}$ is equal to $1/1,000 \text{ mm}$. PM 2.5 is small enough to be breathed deep into the lungs. This filter should be replaced every six months because it can not be cleaned.

Work & Servicing

32. Auto grille panel (Option)

Grille and air filter cleaning can be performed without need for a stepladder by lowering the grille.

33. Drain pump mechanism

For Cassette (Standard)
For Ducted, Suspended, Wall Mounted (Option)

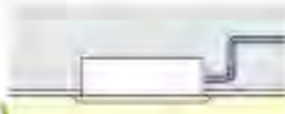

Steeper gradient realises more efficient condensate drainage. High-lift is especially useful for long lengths of drain piping.

34. Pre-charged for up to 30 m, 10 / 15 m

If refrigerant piping length does not exceed 30 m, 10 m, or 15 m, there is no need for on-site gas charging.

•30 m: RZF series •10 m: RZFC50-71DV1G, 35EV1G
•15 m: RZFC100-140DV1G, 100-140DY1G

35. Long-life filter (Option)

Maintenance is not required for one year*.
The filter is washable and can be reused.
*For dust concentration of 0.15 mg/m^3

36. Filter sign

The filter sign warns you when it is time to clean the filter.
*When using a wired remote controller the sign is displayed in the LCD.
When using a wireless remote controller the filter sign lamp illuminates on the signal receiver unit.

37. Low gas pressure detection

Insufficient gas charging is normally hard to detect. During test run after installation and regular inspection, the refrigerant level is monitored by a microprocessor to maintain proper gas pressure. Reliability is assured and maintenance and inspection can be carried out more quickly.

38. Emergency operation

Even if there is a malfunction elsewhere in the system, the fan or compressor can still be operated. (depending on the malfunction)

39. Self-diagnosis function

The operating parameters of indoor and outdoor units, and sensor data at critical locations throughout the system, are constantly monitored using a microcomputer. To facilitate quick response in the event of a malfunction, a message appears on the LCD of the remote controller and an LED on the unit illuminates.

40. Service contact display

When installing the unit, registration of the service contact is available to the wired remote controller.

Control

41. Auto-restart

If there is a power outage while the equipment is operating, operations will restart in the same mode as before the power cut when electricity is restored.

42. Control by 2 remote controllers

Using 2 remote controllers you can operate the equipment locally or from a remote location.

*When a wireless remote controller is used, it is not possible to use 2 wireless remote controllers.

43. Group control by 1 remote controller

You can turn up to 16 indoor units ON/OFF with a single remote controller. (When using connected indoor units, the settings must all be the same and on/off will be simultaneous.)

44. External equipment interlock (Option)

Human presence is detected by the built-in infrared presence sensor in the sensing panel, and the presence detection signal can be output and interlocked with external equipment. Power conservation is possible through the interlock of external equipment, such as lighting, with the infrared presence sensor.

*Adaptor for Wiring (and installation box) is necessary.

45. External signal forced OFF and ON/OFF operation

The air conditioner can be interlocked with the keycard system and turned ON/OFF by locking and unlocking the room.

The air conditioner can also be turned OFF by the interlock with the ventilation and lighting OFF signal.

*Field setting with remote controller.

46. External command control (Option)

Operation and monitoring is carried out using the contact signal from the operation control box in the building monitoring room.

*Wiring adaptor for electrical appendices (and installation box) is necessary.

47. Central remote control (Option)

Optional central remote controller enables centralised control of up to 1024 indoor units (64 groups) from up to 1 km away.

48. Interlock control with Heat Reclaim Ventilator (Option)

Enables interlocking control with external equipment such as Heat Reclaim Ventilator.

49. DIII-NET communication standard (Option)

Connection to a centralised control system is available without need for an optional adaptor.

Options

50. High-efficiency filter

Two types are available: 65% and 90% colorimetry.

51. Ultra long-life filter

Requires no maintenance for about 4 years* (10,000h) in stores and offices.

*For dust concentration of 0.15 mg/m^3

52. Fresh air intake kit

You can provide air-conditioning with fresh air from outside. Convenient for places where a ventilation fan cannot be installed.

53. Overvoltage PCB

Optional circuit eliminates the need for a stabiliser and offer additional protection for devices in the outdoor unit, such as its fan motor and compressor.



CEILING MOUNTED CASSETTE TYPE <Round Flow> (1 Phase) **Cooling only**

		50	60	71	100	126	
Model Name	Indoor unit	FCF50CVMG	FCF60CVMG	FCF71CVMG	FCF100CVMG	FCF126CVMG	
	Outdoor unit	RZF50CV1G	RZF60CV1G	RZF71CV1G	RZF100CV1G	RZF126CV1G	
Power supply	Outdoor unit	1 Phase, 220-240V, 50Hz					
Cooling Capacity ^{1,2} Rated (Min. - Max.)	kW	5.0 (2.1-5.9)	6.0 (2.1-7.0)	7.1 (2.1-8.2)	9.5 (3.3-11.4)	11.0 (5.2-13.9)	
	Btu/h	17,100 (7,200-20,100)	20,500 (7,200-23,900)	24,200 (7,200-28,000)	32,400 (11,300-38,900)	37,500 (17,800-47,400)	
Power consumption	Cooling ¹	1.04	1.37	1.88	2.51	3.28	
COP		4.83	4.38	3.78	3.78	3.35	
Weighted COP		5.90	5.68	5.15	4.91	4.25	
Tick grade		4	4	3	3	2	
Indoor unit	Colour	Fresh white					
	Unit	—					
	Decoration panel	Fresh white					
	Airflow rate (H / HM / M / ML / L)	m ³ /min	23.0 / 21.0 / 18.5 / 16.0 / 13.5			34.5 / 31.0 / 27.5 / 24.0 / 20.0	
		cfm	812 / 741 / 653 / 565 / 477			1,218 / 1,094 / 971 / 847 / 706	
	Sound pressure level ³ (H / HM / M / ML / L)	dB(A)	37.0 / 34.5 / 32.0 / 29.5 / 27.5			45.0 / 41.5 / 38.0 / 35.0 / 32.5	
						46.0 / 43.0 / 40.0 / 36.0 / 32.5	
	Dimensions (H×W×D)	Unit	256×840×840			298×840×840	
		Decoration panel	mm			50×950×950	
	Machine weight	Unit	kg			24	
Decoration panel		kg			5.5		
Certified operation range	°CWB	14 to 25					
Outdoor unit	Colour	Ivory white					
	Coil	Type					
	Compressor	Type					
	Motor output	kW			1.6		
	Refrigerant charge (R32)	kg			1.3 (Charged for 30 m)		
	Sound pressure level ³	Cooling	dB(A)			49	
		Night quiet mode	dB(A)			45	
	Dimensions (H×W×D)	mm			595×845×300		
	Machine weight	kg			41		
	Certified operation range	°CDB	21 to 46				
Piping connections	Liquid (Flare)	mm			φ9.5		
	Gas (Flare)	mm			φ15.9		
	Drain	Indoor unit	mm			VP25 (I.D.φ25×O.D.φ32)	
		Outdoor unit	mm			φ26.0 (Hole)	
Max. interunit piping length	m	50 (Equivalent length 70)					
Max. installation level difference	m	30					
Heat insulation		Both liquid and gas piping					

Note :
¹Rated cooling capacities are based on the following conditions: Indoor temp., 27°CDB, 19°CWB; outdoor temp. 35°CDB, 24°CWB. Equiv. refrigeration piping, 7.5 m (horizontal).
²Capacities are net, including a deduction for cooling for indoor fan motor heat.
³The operation sound is measured in anechoic chamber. If it is measured under the actual installation conditions, it is normally over the set value due to environmental noise and sound reflection.

CEILING MOUNTED CASSETTE TYPE <Round Flow> (3 Phase) **Cooling only**



		100	125	140	
Model Name	Indoor unit	FCFC100DVMG	FCFC125DVMG	FCFC140DVMG	
	Outdoor unit	RZFC100DY1G	RZFC125DY1G	RZFC140DY1G	
Power supply	Outdoor unit	3 Phase, 380-415V, 50Hz			
Cooling Capacity ^{1,2} Rated (Min. - Max.)	kW	10.0 (3.3-11.4)	12.5 (5.2-13.9)	14.0 (5.2-14.8)	
	Btu/h	34,100 (11,300-38,900)	42,700 (17,800-47,400)	47,800 (17,800-50,500)	
Power consumption	Cooling ¹	3.23	4.18	4.75	
COP		3.10	2.99	2.95	
Indoor unit	Colour	Fresh white			
	Unit	—			
	Decoration panel	Fresh white			
	Airflow rate (H / M / L)	m ³ /min	34 / 27 / 20		36 / 29 / 21
		cfm	1,200 / 953 / 706		1,271 / 1,024 / 741
	Sound pressure level ³ (H / M / L)	dB(A)	45 / 38 / 33		46 / 40 / 33
	Dimensions (H×W×D)	Unit	298×840×840		
		Decoration panel	mm		
	Machine weight	Unit	kg		
Decoration panel		kg			
Certified operation range	°CWB	14 to 25			
Outdoor unit	Colour	Ivory white			
	Coil	Type			
	Compressor	Type			
	Motor output	kW		2.40	
	Refrigerant charge (R32)	kg		1.35 (Charged for 15 m)	
	Sound pressure level ³	Cooling	dB(A)		56
	Dimensions (H×W×D)	mm		695×930×350	
	Machine weight	kg		46	
	Certified operation range	°CDB	21 to 46		
Piping connections	Liquid (Flare)	mm		φ9.5	
	Gas (Flare)	mm		φ15.9	
	Drain	Indoor unit	mm		VP25 (I.D.φ25×O.D.φ32)
		Outdoor unit	mm		φ18.0 (Hole)
Max. interunit piping length	m	50 (Equivalent length 70)			
Max. installation level difference	m	30			
Heat insulation		Both liquid and gas piping			

Note :
¹Rated cooling capacities are based on the following conditions: Indoor temp., 27°CDB, 19°CWB; outdoor temp. 35°CDB, 24°CWB. Equiv. refrigeration piping, 7.5 m (horizontal).
²Capacities are net, including a deduction for cooling for indoor fan motor heat.
³The operation sound is measured in anechoic chamber. If it is measured under the actual installation conditions, it is normally over the set value due to environmental noise and sound reflection.



COMPACT MULTI FLOW CEILING MOUNTED CASSETTE TYPE (1 Phase)

		35		50		
Model Name	Indoor unit	FFFC35AVMG		FFFC50AVMG		
	Outdoor unit	RZFC35EV1G		RZFC50DV1G		
Power supply	Outdoor unit	1 Phase, 220-240V, 50Hz				
Cooling Capacity ^{1,2} Rated (Min. - Max.)	kW	3.5 (1.7-4.0)		5.0 (2.2-6.5)		
	Btu/h	11,900 (5,800-13,700)		17,100 (7,500-22,200)		
Power consumption	Cooling ¹	0.91		1.34		
COP		3.85		3.73		
Weighted COP		4.80		4.47		
Tick grade		3		2		
Indoor unit	Colour	White				
	Unit	White				
	Decoration panel	White				
	Airflow rate (H/ML)	m ³ /min	10.0 / 8.5 / 6.5		12.0 / 10.0 / 7.5	
		cfm	353 / 300 / 229		424 / 353 / 265	
	Sound pressure level ³ (H/ML)	34.0 / 30.5 / 25.0		39.0 / 34.0 / 27.0		
	Dimensions (H×W×D)	Unit	260×575×575 (+63) ⁴			
		Decoration panel	46×620×620			
Machine weight	Unit	16		17.5		
	Decoration panel			2.8		
Certified operation range	°CWB	14 to 25				
Outdoor unit	Colour	Ivory white				
	Coil	Type	Cross fin coil		Micro channel	
	Compressor	Type	Hermetically sealed swing type			
		Motor output	0.80		1.20	
	Refrigerant charge (R32)	kg	0.73 (Charged for 10 m)		0.70 (Charged for 10 m)	
	Sound pressure level ³	Cooling	48		49	
	Dimensions (H×W×D)	mm	550×675×284		595×845×300	
	Machine weight	kg	28		34	
Certified operation range	°CDB	21 to 46				
Piping connections	Liquid (Flare)	mm	φ6.4			
	Gas (Flare)	mm	φ9.5		φ12.7	
	Drain	Indoor unit	VP20 (I.D.φ20×O.D.φ26)			
		Outdoor unit	φ16.0 (Hole)		φ18.0 (Hole)	
Max. interunit piping length	m	20 (Equivalent length 45)		30 (Equivalent length 40)		
Max. installation level difference	m	15				
Heat insulation		Both liquid and gas piping				

Note :
¹Rated cooling capacities are based on the following conditions: Indoor temp., 27°CDB, 19°CWB; outdoor temp. 35°CDB, 24°CWB. Equiv. refrigeration piping, 5.0 m (class 35), 7.5 m (class 50-71) (horizontal).
²Capacities are net, including a deduction for cooling for indoor fan motor heat.
³The operation sound is measured in anechoic chamber. If it is measured under the actual installation conditions, it is normally over the set value due to environmental noise and sound reflection.
⁴Dimension including Electric box.

WALL MOUNTED TYPE (1 Phase) Cooling only

		60		
Model Name	Indoor unit	FAFC100AV1G		
	Outdoor unit	RZFC100DV1G		
Power supply	Outdoor unit	1 Phase, 220-240V, 50Hz		
Cooling Capacity ^{1,2} Rated (Min. - Max.)	kW	9.5 (2.3-11.5)		
	Btu/h	32,400 (7,800-39,200)		
Power consumption	Cooling ¹	2.79		
COP		3.41		
Weighted COP		4.17		
Tick grade		2		
Indoor unit	Colour	Pure white		
	Airflow rate (H / HM / M / ML / L / SL)	m ³ /min	25.5 / 23.5 / 21.5 / 19.5 / 17.5 / 15.0	
		cfm	900 / 830 / 759 / 688 / 618 / 530	
	Sound pressure level ³ (H / HM / M / ML / L / SL)	53.0 / 51.0 / 48.0 / 42.0 / 38.0		
	Dimensions (H×W×D)	340×1,200×259		
	Machine weight	18		
	Certified operation range	14 to 25		
Outdoor unit	Colour	Ivory white		
	Coil	Type		
	Compressor	Type		
		Motor output	1.60	
	Refrigerant charge (R32)	kg	1.0 (Charged for 15 m)	
	Sound pressure level ³	Cooling	52	
	Dimensions (H×W×D)	mm	695×930×350	
	Machine weight	kg	44	
Certified operation range	°CDB	21 to 46		
Piping connections	Liquid (Flare)	mm	φ9.5	
	Gas (Flare)	mm	φ15.9	
	Drain	Indoor unit	VP13 (I.D.φ13×O.D.φ18)	
		Outdoor unit	φ18.0 (Hole)	
Max. interunit piping length	m	50 (Equivalent length 70)		
Max. installation level difference	m	30		
Heat insulation		Both liquid and gas piping		

Note :
¹Rated cooling capacities are based on the following conditions: Indoor temp., 27°CDB, 19°CWB; outdoor temp. 35°CDB, 24°CWB. Equiv. refrigeration piping, 7.5 m (horizontal).
²Capacities are net, including a deduction for cooling for indoor fan motor heat.
³The operation sound is measured in anechoic chamber. If it is measured under the actual installation conditions, it is normally over the set value due to environmental noise and sound reflection.
⁴Airflow rate (SL) and sound (SL) are mean silence tap which is available for remote controller ARC466A14 only.



DUCT CONNECTION MIDDLE STATIC PRESSURE TYPE (1 Phase) **Cooling only**

		50	60	71	100	125	140	
Model Name	Indoor unit	FBFC50DVMG	FBFC60DVMG	FBFC71DVMG	FBFC100DVMG	FBFC125DVMG	FBFC140DVMG	
	Outdoor unit	RZFC50DV1G	RZFC60DV1G	RZFC71DV1G	RZFC100DV1G	RZFC125DV1G	RZFC140DV1G	
Power supply	Indoor unit							
	Outdoor unit	1 Phase, 220-240V, 50Hz						
Cooling Capacity ^{1,2} Rated (Min. - Max.)	kW	5.0 (2.1-5.9)	6.0 (2.1-6.1)	7.1 (1.7-8.0)	10.0 (2.5-11.0)	12.5 (5.1-13.9)	14.0 (5.1-14.4)	
	Btu/h	17,100 (7,200-20,100)	20,500 (7,200-20,800)	24,200 (5,800-27,300)	34,100 (8,500-37,500)	42,700 (17,400-47,400)	47,800 (17,400-49,100)	
Power consumption	Cooling ¹	1.50	2.12	2.37	3.17	4.45	5.69	
COP		3.33	2.83	3.00	3.15	2.81	2.46	
Indoor unit	Colour							
	Fan	Airflow rate (H/M/L)	15.5 / 12.0 / 9.0		25.0 / 20.0 / 16.5		36.0 / 30.5 / 25.0	
			547 / 424 / 318		883 / 706 / 582		1,271 / 1,077 / 883	
		External static pressure ³	Rated 30 (30-130)		Rated 40 (40-140)		Rated 50 (50-150)	
		Sound pressure level ⁴ (H/M/L)	37 / 35 / 30		39 / 37 / 34		40 / 37.5 / 35	
		Air filter ⁵						
		Dimensions (H×W×D)	245×700×800		245×1,000×800		245×1,400×800	
		Machine weight	26		36		46	
		Certified operation range	14 to 25					
Outdoor unit	Colour		Ivory white					
	Coil	Type	Micro channel					
	Compressor	Type	Hermetically sealed swing type					
		Motor output	kW	1.20	1.30	1.60	2.40	
		Refrigerant charge (R32)	0.7 (Charged for 10 m)		0.8 (Charged for 10 m)		1.0 (Charged for 15 m)	
		Sound pressure level ⁴ Cooling	49		50		52	
		Dimensions (H×W×D)	595×845×300		695×930×350		990×940×320	
		Machine weight	34		37		44	
		Certified operation range	21 to 46					
Piping connections	Liquid (Flare)	mm	φ6.4		φ9.5			
	Gas (Flare)	mm	φ12.7		φ15.9			
	Drain	Indoor unit	VP25 (I.D.φ25×O.D.φ32)					
		Outdoor unit	φ18.0 (Hole)		φ26.0 (Hole)			
	Max. interunit piping length	30 (Equivalent length 40)			50 (Equivalent length 70)			
	Max. installation level difference	15			30			
	Heat insulation	Both liquid and gas piping						

DUCT CONNECTION MIDDLE STATIC PRESSURE TYPE (3 Phase) **Cooling only**



		100	125	140	
Model Name	Indoor unit	FBFC100DVMG	FBFC125DVMG	FBFC140DVMG	
	Outdoor unit	RZFC100DY1G	RZFC125DY1G	RZFC140DY1G	
Power supply	Indoor unit				
	Outdoor unit	3 Phase, 380-415V, 50Hz			
Cooling Capacity ^{1,2} Rated (Min. - Max.)	kW	10.0 (3.2-11.0)	12.5 (5.4-13.8)	14.0 (5.5-14.1)	
	Btu/h	34,100 (11,600-37,500)	42,700 (18,400-47,100)	47,800 (18,800-48,100)	
Power consumption	Cooling ¹	3.17	5.21	6.22	
COP		3.15	2.40	2.25	
Indoor unit	Colour				
	Fan	Airflow rate (H/M/L)	36.0 / 30.5 / 25.0		
			1,271 / 1,077 / 883		
		External static pressure ³	Rated 50 (50-150)		
		Sound pressure level ⁴ (H/M/L)	40 / 37.5 / 35		
		Air filter ⁵			
		Dimensions (H×W×D)	245×1,400×800		
		Machine weight	46		
		Certified operation range	14 to 25		
Outdoor unit	Colour		Ivory white		
	Coil	Type	Micro channel		
	Compressor	Type	Hermetically sealed swing type		
		Motor output	kW	1.60	2.40
		Refrigerant charge (R32)	1.0 (Charged for 15 m)		
		Sound pressure level ⁴ Cooling	52		
		Dimensions (H×W×D)	695×930×350		
		Machine weight	46		
		Certified operation range	21 to 46		
Piping connections	Liquid (Flare)	mm	φ9.5		
	Gas (Flare)	mm	φ15.9		
	Drain	Indoor unit	VP25 (I.D.φ25×O.D.φ32)		
		Outdoor unit	φ18.0 (Hole)		
	Max. interunit piping length	50 (Equivalent length 70)			
	Max. installation level difference	30			
	Heat insulation	Both liquid and gas piping			

Note :
¹Rated cooling capacities are based on the following conditions: Indoor temp., 27°CDB, 19°CWB; outdoor temp. 35°CDB, 24°CWB. Equiv. refrigeration piping, 7.5 m (horizontal)
²Capacities are net, including a deduction for cooling for indoor fan motor heat.
³External static pressure is changeable in 11 stages by remote controller.
⁴The operation sound is measured in anechoic chamber. If it is measured under the actual installation conditions, it is normally over the set value due to environmental noise and sound reflection.
⁵Air filter is not standard accessory, but please mount it in the duct system of the suction side. Select its dust collection efficiency (gravity method) 50% or more.



CEILING SUSPENDED TYPE (1 Phase) Cooling only

		50	60	71	100	125	140	
Model Name	Indoor unit	FHFC50DV1G	FHFC60DV1G	FHFC71DV1G	FHFC100DV1G	FHFC125DV1G	FHFC140DV1G	
	Outdoor unit	RZFC50DV1G	RZFC60DV1G	RZFC71DV1G	RZFC100DV1G	RZFC125DV1G	RZFC140DV1G	
Power supply	Outdoor unit	1 Phase, 220-240V, 50Hz						
Cooling Capacity ^{1,2} Rated (Min. - Max.)	kW	4.6 (2.1-5.8)	5.4 (2.3-6.5)	6.6 (1.9-8.0)	9.0 (2.3-10.9)	10.0 (4.9-13.9)	10.6 (5.1-14.6)	
	Btu/h	15,700 (7,200-19,800)	18,400 (7,800-22,200)	22,500 (6,500-27,300)	30,700 (7,800-37,200)	34,100 (16,700-47,400)	36,200 (17,400-49,800)	
Power consumption	Cooling ¹	kW	1.38	1.61	1.96	2.51	3.17	
COP		kW/kW	3.34	3.36	3.37	3.59	3.34	
Weighted COP		kW/kW	4.02	4.22	4.19	4.51	4.08	
Tick grade			2	2	2	2	2	
Indoor unit	Colour	White						
	Airflow rate (H / M / L)	m ³ /min	13 / - / 10	17 / - / 14	24 / - / 20	28 / 24 / 20	31 / 27 / 23	34 / 29 / 24
		cfm	459 / - / 353	600 / - / 494	847 / - / 706	988 / 847 / 706	1,094 / 953 / 812	1,200 / 1,024 / 847
	Sound pressure level ³ (H / M / L)	dB(A)	38 / - / 33	39 / - / 35	42 / - / 37	42 / 38 / 34	44 / 41 / 37	46 / 42 / 38
	Dimensions (H×W×D)	mm	195×960×680	195×1,160×680	195×1,400×680	235×1,590×690		
	Machine weight	kg	25	27	32	38		
	Certified operation range	°CWB	14 to 25					
Outdoor unit	Colour	Ivory white						
	Coil	Type	Micro channel					
	Compressor	Type	Hermetically sealed swing type					
		Motor output	kW	1.20	1.30	1.60	2.40	
	Refrigerant charge (R32)	kg	0.7 (Charged for 10 m)		0.8 (Charged for 10 m)	1.0 (Charged for 15 m)	1.9 (Charged for 15 m)	
	Sound pressure level ³	Cooling	dB(A)	49	50	52	54	
	Dimensions (H×W×D)	mm	595×845×300		695×930×350	990×940×320		
	Machine weight	kg	34	37	44	64		
Certified operation range	°CDB	21 to 46						
Piping connections	Liquid (Flare)	mm	φ6.4		φ9.5			
	Gas (Flare)	mm	φ12.7		φ15.9			
	Drain	Indoor unit	mm	VP20 (I.D.φ20×O.D.φ26)				
Outdoor unit		mm	φ18.0 (Hole)		φ26.0 (Hole)			
Max. interunit piping length	m	30 (Equivalent length 40)			50 (Equivalent length 70)			
Max. installation level difference	m	15			30			
Heat insulation		Both liquid and gas piping						



CEILING SUSPENDED TYPE (3 Phase) Cooling only

		100	125	140		
Model Name	Indoor unit	FHFC100DV1G	FHFC125DV1G	FHFC140DV1G		
	Outdoor unit	RZFC100DY1G	RZFC125DY1G	RZFC140DY1G		
Power supply	Outdoor unit	3 Phase, 380-415V, 50Hz				
Cooling Capacity ^{1,2} Rated (Min. - Max.)	kW	10.0 (3.1-10.9)	12.5 (5.5-13.9)	14.0 (5.4-15.1)		
	Btu/h	34,100 (10,600-37,200)	42,700 (18,800-47,400)	47,800 (18,400-51,500)		
Power consumption	Cooling ¹	kW	3.15	3.93		
COP		kW/kW	3.17	3.18		
Indoor unit	Colour	White				
	Airflow rate (H / M / L)	m ³ /min	28 / 24 / 20	31 / 27 / 23	34 / 29 / 24	
		cfm	988 / 847 / 706	1,094 / 953 / 812	1,200 / 1,024 / 847	
	Sound pressure level ³ (H / M / L)	dB(A)	42 / 38 / 34	44 / 41 / 37	46 / 42 / 38	
	Dimensions (H×W×D)	mm	235×1,590×690			
	Machine weight	kg	38			
	Certified operation range	°CWB	14 to 25			
Outdoor unit	Colour	Ivory white				
	Coil	Type	Micro channel			
	Compressor	Type	Hermetically sealed swing type			
		Motor output	kW	1.60	2.40	
	Refrigerant charge (R32)	kg	1.0 (Charged for 15 m)	1.35 (Charged for 15 m)		
	Sound pressure level ³	Cooling	dB(A)	52	54	56
	Dimensions (H×W×D)	mm	695×930×350	990×940×320		
	Machine weight	kg	46	62		
Certified operation range	°CDB	21 to 46				
Piping connections	Liquid (Flare)	mm	φ9.5			
	Gas (Flare)	mm	φ15.9			
	Drain	Indoor unit	mm	VP20 (I.D.φ20×O.D.φ26)		
Outdoor unit		mm	φ18.0 (Hole)	φ26.0 (Hole)		
Max. interunit piping length	m	50 (Equivalent length 70)				
Max. installation level difference	m	30				
Heat insulation		Both liquid and gas piping				

Note :

¹Rated cooling capacities are based on the following conditions: Indoor temp., 27°CDB, 19°CWB; outdoor temp. 35°CDB, 24°CWB. Equiv. refrigeration piping, 7.5 m (horizontal).

²Capacities are net, including a deduction for cooling for indoor fan motor heat.

³The operation sound is measured in anechoic chamber. If it is measured under the actual installation conditions, it is normally over the set value due to environmental noise and sound reflection.

Indoor unit

CEILING MOUNTED CASSETTE TYPE <Round Flow> DTA116/SVMPC1



	Name of option	Remark	Kit name						
			FCF50CVMG	FCF60CVMG	FCF71CVMG	FCF100CVMG	FCF125CVMG	FCF140CVMG	
1	Decoration panel	Standard panel with Sensing	Fresh white	BYCQ125EEF					
			Black	BYCQ125EEK					
		Standard panel	Fresh white	BYCQ125EAF					
			Black	BYCQ125EAK					
		Designer panel ¹	Fresh white	BYCQ125EAPF					
Auto grille panel ^{2,3}	Fresh white	BYCQ125EBSF							
2	Sealing material of air discharge outlet ⁴	For usage of 3-, 4-way flow	KDBH551C160						
		For usage of 2-way flow	KDBH552C160						
3	Panel spacer		KDB55J160F						
4	Fresh air intake kit	Chamber type ^{5,6}	Without T-duct joint	KDDP55C160 (Components: KDDP55C160-1, KDDP55C160-2) ⁸					
			With T-duct joint	KDDP55C160K (Components: KDDP55C160-1, KDDP55C160K2) ⁸					
		Direct installation type ⁷	KDDP55X160A						
5	High-efficiency filter unit ⁹ (Including filter chamber)	(Colorimetric method 65%)	KAF556D80			KAF556D160			
		(Colorimetric method 90%)	KAF557D80			KAF557D160			
6	Replacement high-efficiency filter ^{9,10}	(Colorimetric method 65%)	KAF552D80			KAF552D160			
		(Colorimetric method 90%)	KAF553D80			KAF553D160			
7	Filter chamber		KDDFP55C160						
8	Replacement long-life filter		KAF5511D160						
9	Replacement long-life filter (Auto grille panel)		KAF5512D160						
10	Ultra long-life filter unit (Including filter chamber) ⁹		KAF555D160						
11	Replacement ultra long-life filter ^{9,10}		KAF550D160						
12	Branch duct chamber ⁴		KDJP55C80			KDJP55C160			
13	Insulation kit for high humidity ^{9,11}		KDTP55K80A			KDTP55K160A			
14	Remote controller	Wireless type	Cooling only	BRC7M635F (Fresh white) / BRC7M635K (Black)					
15	Stylish Remote Controller	Wired type ¹²		BRC1H61W (White) / BRC1H61K (Black)					
16	Navigation Remote Controller	Wired type ¹²		BRC1E63					
17	Simplified remote controller	Wired type ¹²		BRC2E61					
18	Central remote controller ¹³			DCS302CA61					
19	Unified ON/OFF controller ¹³			DCS301BA61					
20	Schedule timer ¹³			DST301BA61					
21	intelligent Touch Controller ¹³			DCS601C51					
22	Adaptor for wiring ¹⁴			BRP11B62					
23	Wiring adaptor for electrical appendices ¹⁴			KRP4AA53					
24	Installation box for adaptor PCB			KRP1H98A					
25	Remote sensor (for indoor temperature)			BRCS01A-5					
26	Wireless LAN connecting adaptor			BRP072C42-1					

Note:

¹When installing designer panel, body height (ceiling required dimension) is 42 mm higher than standard panel. Designer panel cannot operate 2 and 3 way flow.

²A dedicated remote controller for the auto grille panel is included for lowering and raising the suction grille.

³When installing auto grille panel, body height (ceiling required dimension) is 55 mm higher than standard panel.

⁴Circulation airflow is not available with this option.

⁵When installing a fresh air intake kit (chamber type), two air outlet corners are closed.

⁶It is recommended that the volume of outdoor air introduced through the kit is limited to 10% of the maximum airflow rate of the indoor unit. Introducing higher quantities will increase the operating sound and may also influence temperature sensing.

⁷The volume of fresh air for direct installation type is approximately 1% of the indoor unit airflow. The chamber type is recommended when more fresh air is necessary.

⁸Please order using the names of both components instead of set name.

⁹This option cannot be installed to designer panel and auto grille panel.

¹⁰Filter chamber is required.

¹¹Please use in case temperature/humidity inside ceiling may get over 30°C, 80% RH.

¹²Wiring for wired remote controller should be obtained locally.

¹³The indoor unit is equipped standardly with the interface adaptor for SkyAir series. An option is unnecessary.

¹⁴Installation box for adaptor PCB(KRP1H98A) is necessary.

Indoor unit



COMPACT MULTI FLOW CEILING MOUNTED CASSETTE TYPE

No.	Name of option	Remark	Kit name	
			FFFC35AVMG	FFFC50AVMG
1	Grid ceiling panel			BYFQ60CAW
2	Sensor kit 1			BRYQ60AAW
3	Sealing material of air discharge outlet			BDBHQ44C60
4	Fresh air intake kit			KDDQ44XA60
5	Replacement long-life filter			KAF441C60
6	Remote controller	Wireless type Cooling only		BRC7M531W
7	Stylish remote controller	Wired type 2		BRC1H61W (White) / BRC1H61K (Black)
8	Navigation remote controller	Wired type 1,2		BRC1E63
9	Simplified remote controller	Wired type 2		BRC2E61
10	Central remote controller			DCS302CA61
11	Unified ON / OFF controller			DCS301BA61
12	Schedule timer			DST301BA61
13	intelligent Touch Controller			DCS601C51
14	Adaptor for wiring			BRP11B62
15	Wiring adaptor for electrical appendices(2)			KRP4AA53
16	Installation box for adaptor PCB			KRP1BB101
17	Remote sensor (for indoor temperature)			BRCS01A-6
18	Wireless LAN connecting adaptor			BRP072C42-1

Note :

¹When sensor kit (BRYQ60AAW) is used, BRC1E63 must be used as wired remote controller. BRC2E61 does not have sensor function.

²Wiring for wired remote controller should be obtained locally.

DUCT CONNECTION MIDDLE STATIC PRESSURE TYPE



No.	Name of option	Remark	Kit name					
			FBFC60DVMG	FBFC60DVMG	FBFC71DVMG	FBFC100DVMG	FBFC125DVMG	FBFC140DVMG
1	Long-life filter 1		KAF631C56		KAF631C80			KAF631C160
2	High-efficiency filter 1	65%	KAF632C56		KAF632C80			KAF632C160
		90%	KAF633C56		KAF633C80			KAF633C160
3	Filter chamber(for rear suction)1		KDDFP63B56		KDDFP63B80			KDDFP63B160
4	Service panel	Fresh white	KTBJ25K56F		KTBJ25K80F			KTBJ25K160F
5	Air discharge adaptor		KDAP25A56A		KDAP25A71A			KDAP25A140A
6	Shield plate for side plate							KDBD63A160
7	Remote controller	Wireless type Cooling only						BRC4C66
8	Stylish remote controller	Wired type 2						BRC1H61W (White) / BRC1H61K (Black)
9	Navigation remote controller	Wired type 2						BRC1E63
10	Simplified Remote Controller	Wired type 2						BRC2E61
11	Remote sensor (for indoor temperature)							BRCS01A-4
12	Adaptor for wiring 3							BRP11B62*
13	Wiring adaptor for electrical appendices(2) 3							KRP4AA51*
14	Mounting plate for adaptor PCB.3,4,5							KRP4A98
15	Central remote controller 6							DCS302CA61
16	Unified ON/OFF controller 6							DCS301BA61
17	Schedule timer 6							DST301BA61
18	intelligent Touch Controller 6							DCS601C51
19	Drain pump kit							BDU24AMD2
20	Wireless LAN connecting adaptor							DTA116A51 + SVMPC1

Note:

¹If installing high efficiency filter and long-life filter to the unit, filter chamber is required.

²Wiring for wired remote controller should be obtained locally.

³Mounting plate is necessary for each adaptor marked ★.

⁴Up to 2 adaptors can be fixed for each mounting plate.

⁵Only one mounting plate can be installed for each indoor unit.

⁶The indoor unit is equipped standardly with the interface adaptor for SkyAir series. An option is unnecessary.

Indoor unit

CEILING MOUNTED CASSETTE TYPE <Round Flow>
D'Mobile/DTA116/SVMPC1



No.	Name of option	Remark	Kit name		
			FCFC100DVMG	FCFC125DVMG	FCFC140DVMG
1	Decoration panel	Standard panel with Sensing	Fresh white	BYCQ125EEF	
			Black	BYCQ125EEK	
		Standard panel	Fresh white	BYCQ125EAF	
			Black	BYCQ125EAK	
		Designer panel ¹	Fresh white	BYCQ125EAPF	
Auto grille panel ^{2,3}	Fresh white	BYCQ125EBSF			
2	Sealing material of air discharge outlet ⁴	For usage of 3-, 4-way flow		KDBH551C160	
		For usage of 2-way flow		KDBH552C160	
3	Panel spacer			KDB55J160F	
4	Fresh air intake kit	Chamber type ^{5,6}	Without T-duct joint	KDDP55C160 (Components: KDDP55C160-1, KDDP55C160-2) ⁸	
			With T-duct joint	KDDP55C160K (Components: KDDP55C160-1, KDDP55C160K2) ⁸	
		Direct installation type ⁷		KDDP55X160A	
5	High-efficiency filter unit ⁹ (Including filter chamber)	(Colorimetric method 65%)		KAF556D160	
		(Colorimetric method 90%)		KAF557D160	
6	Replacement high-efficiency filter ^{9,10}	(Colorimetric method 65%)		KAF552D160	
		(Colorimetric method 90%)		KAF553D160	
7	Filter chamber			KDDFP55C160	
8	Replacement long-life filter			KAF5511D160	
9	Replacement long-life filter (Auto grille panel)			KAF5512D160	
10	Ultra long-life filter unit (Including filter chamber) ⁹			KAF555D160	
11	Replacement ultra long-life filter ^{9,10}			KAF550D160	
12	Branch duct chamber ⁴			KDJP55C160	
13	Insulation kit for high humidity ^{9,11}			KDTP55K160A	
14	Remote controller	Wireless type	Cooling only	BRC7M635F (Fresh white) / BRC7M635K (Black)	
15	Stylish Remote Controller	Wired type ^{12,16}		BRC1H61W (White) / BRC1H61K (Black)	
16	Navigation Remote Controller	Wired type ¹²		BRC1E63	
17	Simplified remote controller	Wired type ¹²		BRC2E61	
18	Central remote controller ¹³			DCS302CA61	
19	Unified ON/OFF controller ¹³			DCS301BA61	
20	Schedule timer ¹³			DST301BA61	
21	Intelligent Touch Controller ¹³			DCS601C51	
22	Adaptor for wiring ¹⁴			BRP11B62	
23	Wiring adaptor for electrical appendices ¹⁴			KRP4AA53	
24	Installation box for adaptor PCB			KRP1H98A	
25	Remote sensor (for indoor temperature)			BRCS01A-5	
26	Wireless LAN connecting adaptor			DTA116A51 + SVMPC1	

Note:
¹When installing designer panel, body height (ceiling required dimension) is 42 mm higher than standard panel. Designer panel cannot operate 2 and 3 way flow.
²A dedicated remote controller for the auto grille panel is included for lowering and raising the suction grille.
³When installing auto grille panel, body height (ceiling required dimension) is 55 mm higher than standard panel.
⁴Circulation airflow is not available with this option.
⁵When installing a fresh air intake kit (chamber type), two air outlet corners are closed.
⁶It is recommended that the volume of outdoor air introduced through the kit is limited to 10% of the maximum airflow rate of the indoor unit. Introducing higher quantities will increase the operating sound and may also influence temperature sensing.

⁷The volume of fresh air for direct installation type is approximately 1% of the indoor unit airflow. The chamber type is recommended when more fresh air is necessary.
⁸Please order using the names of both components instead of set name.
⁹This option cannot be installed to designer panel and auto grille panel.
¹⁰Filter chamber is required.
¹¹Please use in case temperature/humidity inside ceiling may get over 30°C, 80% RH.
¹²Wiring for wired remote controller should be obtained locally.
¹³The indoor unit is equipped standardly with the interface adaptor for SkyAir series. An option is unnecessary.
¹⁴Installation box for adaptor PCB(KRP1H98A) is necessary.

Round flow type: List of optional parts required to achieve different flow patterns

For each flow pattern – all round, 4-way, 3-way, 2-way, branch duct connection – the compatibility of each independently installed option (shown in the column on the left) to accessory options (listed across the top of each table) is shown in the cells where the relevant row and column intersect. A circle (O) indicates compatibility, and a cross (X) indicates incompatibility. Any options not shown below are not suitable for independent or accessory installation.

All round flow • 4-way flow

Optionally installable optional parts		Optional accessory parts							
		Designer panel	Auto grille panel	Panel spacer ¹	Fresh air intake kit (Chamber type) ^{1,2}	Fresh air intake kit (Direct installation type)	Insulation kit for high humidity	High-efficiency filter unit ²	Ultra long-life filter unit ²
Panel/grille related	Designer panel		X	O	O	O	X	X	X
	Auto grille panel	X		O	O	O	X	X	X
	Panel spacer ¹	O	O		O	O	X	O	O
Auxiliary function related	Fresh air intake kit (Chamber type) ^{1,2}	O	O	O		X	X	O	O
	Fresh air intake kit (Direct installation type)	O	O	O	X		O	O	O
	Insulation kit for high humidity	X	X	X	X	O		X	X
Filter related	High-efficiency filter unit ²	X	X	O	O	O	X		X
	Ultra long-life filter unit ²	X	X	O	O	O	X	X	

3-way flow • 2-way flow⁵

Optionally installable optional parts		Optional accessory parts							
		Designer panel	Auto grille panel	Panel spacer ^{1,3}	Fresh air intake kit (Chamber type) ^{1,2}	Fresh air intake kit (Direct installation type)	Insulation kit for high humidity	High-efficiency filter unit ²	Ultra long-life filter unit ²
Panel/grille related	Auto grille panel	X		△	O	O	X	X	X
	Panel spacer ^{1,3}	X	△		△	△	X	X	△
Auxiliary function related	Fresh air intake kit (Chamber type) ^{1,2}	X	O	△		X	X	X	O
	Fresh air intake kit (Direct installation type)	X	O	△	X		O	X	O
	Insulation kit for high humidity	X	X	X	X	O		X	X
Filter related	Ultra long-life filter unit ²	X	X	△	O	O	X	X	

Branch duct connection

Optionally installable optional parts		Optional accessory parts							
		Designer panel	Auto grille panel	Panel spacer ¹	Fresh air intake kit (Chamber type) ^{1,2}	Fresh air intake kit (Direct installation type)	Insulation kit for high humidity	High-efficiency filter unit ²	Ultra long-life filter unit ²
Branch duct chamber ¹	1-way branch / unit 3-way flow	O	O	O	O	O ⁴	X	X	O
	2-way branch / unit 2-way flow	X	O	X	O	O ⁴	X	X	O
	1-way branch / unit 2-way flow	X	O	X	O	O ⁴	X	X	O

1. In some cases, depending on how the unit is embedded in the ceiling, use of branch ducts and fresh air intake kits may not be possible. Before starting installation work make sure to check whether or not joint installation is possible. In particular, ensure that the lower fixing position caused by the addition of panel spacers is acceptable.
 When branch ducts are used, circulation airflow is not available.
 2. When two different types of optional chambers are used together, a fresh air intake kit must be installed in the upper position.
 3. It is not possible to use panel spacers in a 2-way flow installation. (△)
 4. It is not possible to install a branch duct on the same side to which a fresh air intake kit (direct mount) is installed.
 5. When 3-way or 2-way flow is selected, circulation airflow is not available.



CEILING SUSPENDED TYPE

No.	Name of option	Remark	Kit name					
			FHFC50DV1G	FHFC60DV1G	FHFC71DV1G	FHFC100DV1G	FHFC125DV1G	FHFC140DV1G
1	Replacement long-life filter	Resin net	KAFJ501D56	KAFJ501D80	KAFJ501D112	KAF501B160		
2	Fresh air intake kit		—			KDDQ50A140		
3	Drain pump kit		KDU50N60VE	KDU50N125VE		KDU50R160		
4	L-type piping kit (for upward direction)		KHFP5M63	KHFP5M160		KHFP5N160		
5	Remote controller	Wireless type Cooling only	BRC7EA66			BRC7GA56		
6	Stylish remote controller	Wired type ¹	BRC1H61W (White) / BRC1H61K (Black)					
7	Navigation remote controller	Wired type ¹	BRC1E63					
8	Simplified remote controller	Wired type ¹	BRC2E61					
9	Central remote controller		DCS302CA61 ²			DCS302CA61 ³		
10	Unified ON/OFF controller		DCS301BA61 ²			DCS301BA61 ³		
11	Schedule timer		DST301BA61 ²			DST301BA61 ³		
12	intelligent Touch Controller		DCS601C51 ²			DCS601C51 ³		
13	Adaptor for wiring		BRP11B61					
14	Wiring adaptor for electrical appendices ⁴		KRP4AA52					
15	Installation box for adaptor PCB		KRP1CA93			KRP1D93A		
16	Interface adaptor for SkyAir series		DTA112BA51			—		
17	Remote sensor (for indoor temperature)		BRCS01A-1			BRCS01A-4		
18	Electrical box with earth terminal (3 blocks)		KJB311AA					
19	Electrical box with earth terminal (2 blocks)		KJB212AA					
20	Wireless LAN connecting adaptor		DTA112ABA51 + DTA116A51 + SVMPC1					

Note: ¹Wiring for wired remote controller should be obtained locally.
²This optional accessory requires DTA112BA51.
³The indoor unit is equipped standardly with the interface adaptor for SkyAir series. An option is unnecessary.
⁴Installation box for adaptor PCB (KRP1CA93, KRP1D93A) is necessary.

WALL MOUNTED TYPE

No.	Name of option	Remark	Kit name
			FAFC100AV1G
1	Titanium apatite deodorizing filter (without frame)	Resin net	KAF970A48
2	Dust collection filter (PM2.5 filter) without frame ¹		BAFP046A41
3	Remote controller	Wired type ² Cooling only	BRC073A5
4	Remote controller loss prevention with the chain		KKF910A4
5	Central remote controller ³		DCS302CA61 (Need KRP928BB2S)
6	Unified ON/OFF controller ³		DCS301BA61 (Need KRP928BB2S)
7	Schedule timer ³		DST301BA61 (Need KRP928BB2S)
8	Wiring adaptor for timer clock / remote controller (Normal open pulse contact / normal open contact) ³		KRP413BB1S
9	Interface adaptor for DIII-NET		KRP928BB2S
10	Wireless LAN connecting adaptor ³		BRP072C42

Note: ¹Two set of BAFP046A41 is needed for 1 indoor unit. One set of BAFP046A41 has 2 pcs of filters and 1 indoor unit needs 3 pcs of filters.
²Wiring for wired remote controller should be obtained locally.
³It cannot be used with wired remote controller.

Indoor unit

CEILING MOUNTED CASSETTE TYPE <Round Flow>
Model FCF50 – FCF125

Outdoor unit

No.		Name of option	Kit name		
			RZF60/80/71CV1G	RZF100CV1G	RZF125CV1G
1	Central drain plug		KKP014A4	KKP937A4	KKPJ5G280
2	Fixture for preventing overturning		—	—	KKTP5B112
3	Wire fixture for preventing overturning		—	—	K-KYZP15C
4	Demand adaptor		—	KRP58M51	KRP58M51+EKMKSA1
5	Overvoltage PCB	1 Phase	BRV2BPSF	BRV2BPSS	BRV2BPL

Indoor unit

CEILING MOUNTED CASSETTE TYPE <Round Flow>
FCFC100-140

CEILING SUSPENDED TYPE, WALL MOUNTED TYPE, DUCTED CONNECTION TYPE

Outdoor unit

No.		Name of option	Kit name			
			RZFC35EV1G	RZFC50/60/71DV1G	RZFC100DV1G	RZFC125/140DV1G
		1 Phase	RZFC35EV1G	RZFC50/60/71DV1G	RZFC100DV1G	RZFC125/140DV1G
		3 Phase	—	—	RZFC100DY1G	RZFC125/140DY1G
1	Central drain plug		KKP937A4	KKP014A4	KKP937A4	KKPJ5G280
2	Fixture for preventing overturning		—	—	—	KKTP5B112
3	Wire fixture for preventing overturning		—	—	—	K-KYZP15C

Smart Control for SkyAir & iSmile series

Control all air conditioners in and out of the premises with Daikin Smart Control by adding adaptors (refer to page 66 for more information).

Do away with the common remote controller. Conveniently control at ease with personal smart devices.

Features



SkyAir units can be controlled and monitored remotely from inside and outside of the premise



Weekly scheduling to suit the office needs (up to 6 actions per day)



Malfunction alerts and error code tracing are reported automatically to the user for prompt servicing



Covid-19 measure where touchpoints are reduced for controlling SkyAir unit using personal smart device instead of a common remote controller





Daikin Mobile Controller Application
FREE DOWNLOAD



Wifi Connection Adaptor





Accessory is required for smart control

	WiFi Adaptor		Smart Control SVM		
	BRP072C42-1	BRP072C42	DTA112ABA51	DTA116A51	SVMPC1
No. of FCU Connection	1	1	1	16	64
CEILING MOUNTED CASSETTE TYPE FCF50 - FCF125 	●				
CEILING MOUNTED CASSETTE TYPE FCFC100 - FCFC140 				●	●
MINI CEILING MOUNTED CASSETTE TYPE FFFC35 - FFFC50 	●				
DUCT CONNECTION MIDDLE STATIC PRESSURE TYPE FBFC50 - FBFC140 				●	●
CEILING SUSPENDED TYPE FHC50 - FHFC140 			●	●	●
WALL MOUNTED TYPE FAFC100 		●			

Note:
*In the event of a combination of various type of FCU, please refer to Daikin sales personnel for more details.

Indoor Air Quality (IAQ)

Perfecting the Air is a top priority. At Daikin, there are a variety of Air Quality (IAQ) solutions that improves the air in premises. This keeps the indoor air clean and disinfect.

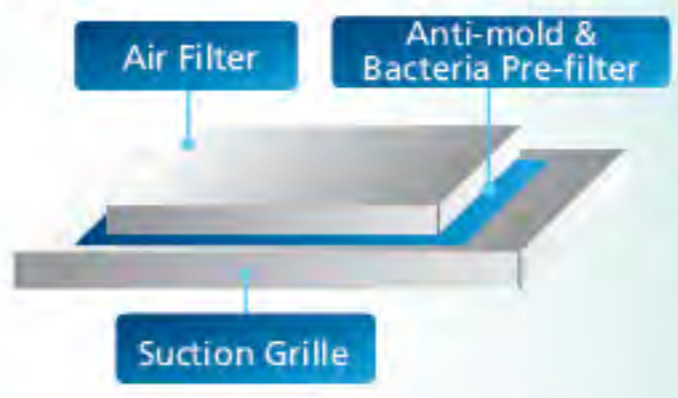
IAQ SOLUTIONS	DESCRIPTION	FEATURES
<p>ANTIMICROBIAL TREATMENT*</p> 	<p>This treatment contains 3 main additives (Titanium, Dioxide, Silver Ions, Quaternary Ammonium) to maximize the Antimicrobial and self-cleaning properties on the cooling coil surface that is coated with it.</p> <p>This reduces chances of fouling on the cooling coil, improve Indoor Air Quality, and lastly enhances the maintainability and lifespan.</p> <p>Applicable models: All FCUs</p>	<ul style="list-style-type: none"> ● Anti-Fungal / Anti-Bacteria ● Ozone Free ● Superior Corrosion Protection ● Superior Hydrophobic ● Water Based ● Non-Flammable
<p>BIO-ANTIBODY FILTER*</p> 	<p>Installation Method</p>  <ul style="list-style-type: none"> ● Replacement is advisable for every 3 months ● 2 sheets of filter per package ● Applicable models: All FCUs 	<ul style="list-style-type: none"> ● Suppress virus effectively within one minute. ● No chemical substance/method is used ● Easy to install
<p>ANTI-MOLD & BACTERIA PRE-FILTER</p> 	<p>Installation Method</p>  <ul style="list-style-type: none"> ● Can be washed and reused for up to 6 times ● 1 sheet or 1 roll of filter per package, depending on usage 	<ul style="list-style-type: none"> ● Stop growth of mold and bacteria ● Eliminate the smell and mildew stain ● Washable and reusable



Perfecting the Air

Warning



- Ask a qualified installer or contractor to install this product. Do not try to install the product by yourself. Improper installation can result in water or refrigerant leakage, electrical shock, fire or explosion.
- Use only those parts and accessories supplied or specified by Daikin. Ask a qualified installer or contractor to install those parts and accessories. Use of unauthorised parts and accessories or improper installation of parts and accessories can result in water or refrigerant leakage, electrical shock, fire or explosion.
- Read the user's manual carefully before using this product. The user's manual provides important safety instructions and warnings. Be sure to follow these instructions and warnings.

If you have any enquiries, please contact your local importer, distributor and/or retailer.

Cautions on product corrosion

1. Air conditioners should not be installed in areas where corrosive gases, such as an acidic or alkaline gas, are produced.
2. When installing outdoor units in coastal areas, be sure to contact your local distributor and avoid direct exposure of the units to sea breezes.

Singapore Main Office

DAIKIN AIRCONDITIONING (SINGAPORE) PTE LTD

10 Ang Mo Kio Industrial Park 2, Singapore 569501

☎ 6583 8888 ✉ sales@daikin.com.sg

🕒 Office Operating Hours

Monday to Friday: 8.30 am to 6.00 pm
Sat, Sun & Public Holiday: Closed

🕒 Showroom Opening Hours

Monday to Friday: 9.00 am to 6.00 pm
Sat, Sun & Public Holiday: Closed

Find us on **DAIKIN SINGAPORE**

CALL CENTER

(SPARE PART / SERVICE DEPARTMENT)

☎ 6311 8686

☎ 6349 7313

🕒 Operating Hours

Monday to Friday: 9.00 am to 5.00 pm
Saturday: 9.00 am to 12.00 pm
Sun & Public Holiday: Closed



www.daikin.com.sg

SGPCS2101